

gorenje
Life Simplified



FREESTANDING APPLIANCES

2018



QUALITY AND TRADITION

Gorenje has been producing high-quality home appliances for over 60 years. It is committed to the research and development and continuous technological improvement to its production processes. Drawing on Slovenian tradition and European values, Gorenje remains among the leading home appliance manufacturers in Europe. We are proud of every product that leaves our factories as we are aware that it was produced and tested to meet the stringent European environment protection standards.





COOKERS

04



RETRO COLLECTION

20



COOLING

34



WASHING MACHINES

52



TUMBLE DRYERS

66



DISHWASHERS

78





WE MAKE IT SIMPLIFIED. YOU MAKE IT PERFECT.

Freestanding Cookers

Ready to introduce some delicious moments to your kitchen? With the **new Gorenje HomeMade cookers**, this becomes charmingly simple. Prepare your favourite food just like in a traditional wood-burning oven or impress your family with a range of tasty experiences. We designed our cookers with **smart** and **user-friendly solutions**, so you can rely on them and just add your final touch.



HomeMade shape

All the qualities of baking in wood-burning ovens

The characteristic rounded shape is one of the most beneficial features of Gorenje cookers. Inspired by traditional wood-burning ovens, it enables hot air to move around freely. Since the food is

heated evenly and from all sides, it is always perfectly done: crispy on the outside and juicy on the inside.



SuperSize

Ready for XXL recipes

Gorenje cookers offer enlarged baking surface and use of extra big trays. Innovative solutions enable optimised energy consumption and evenly cooked food, regardless of the quantity. Full oven width is efficiently used while superior technology makes sure the food is evenly done on all levels.



BigSpace

More space for greater cooking freedom

The increased capacity of the oven (up to 70 litres) allows preparing bigger quantities of food at the same time. The optimised airflow circulates inside the oven completely freely and with their BigSpace cavity Gorenje cookers can easily accommodate even a huge turkey.



MultiAir Technology

Perfect from all sides

MultiAir technology guarantees the optimal circulation of heat within the oven. Due to smartly positioned ventilation openings on the back wall and the unique rounded shape, air is spread evenly throughout the oven. The fan pushes hot air around the entire oven

volume, making the food perfectly baked on all sides. The dynamic air movement also allows simultaneous baking on multiple levels without smells and flavours mixing together.



MultiLevel Baking

Many dishes in one go

Combination of MultiAir technology and HomeMade shape helps reach the toughest objective: preparing **up to 4 trays** of dishes at once. The good news: the flavours and smells don't mix. Smart air distribution ensures that the food is evenly baked on every level.



AquaClean

Simple, casual cleaning

Due to special high-quality enamel, AquaClean function brings even more efficient and user-friendly way of cleaning the oven cavity. All it takes is to pour half a litre of water into a baking tray and turn AquaClean on after each baking. In just 30 minutes, the results are visible on the entire surface and the baking trays. Stains and grease are softened and can be wiped away easily with a soft cloth.



 **OpenView**
Excellent overview

Advanced and even double lighting featured in some models of cookers enable clear view of the large oven cavity. Combined with special design of the glass door, this brings excellent overview of the baking process.



 **XXL Storage drawer**
Everything neatly within reach

A specially large and deep drawer for storing larger cookware or cooking utensils. Trays, baking pans, tableware - have everything you need at hand with this convenient and spacious storage solution.



 **GentleClose**
A soft touch is enough

Only a soft touch is needed to close the cooker door smoothly, without any noise.



DirectTouch

Perfect results at your fingertips

Simple control of baking and cooking process by touching a screen. Large and intelligible symbols take the remarkable technology to another level with clarity and simplicity of use.



TouchFree coating

Shiny and fingerprint-free finish

All stainless steel surfaces are coated with a special TouchFree film that prevents fingerprints markings, leaving the surface always shiny and making cleaning much easier.



Extra deep baking tray

Deep enough for all appetites

Higher sides of this extra deep baking tray prevent the fat from splattering and burning onto the oven cavity walls. It is perfect for making meals such as lasagne and roasted meat.



MeatProbe

Perfectly roasted, every time

With the meat probe it is easy to achieve perfect and precise baking results. By controlling the temperature inside the meat, the MeatProbe manages the entire process and even activates the alarm when the time is right and the dish is perfectly done.



UltraCoolDoor

Made to be touched – anytime, all the time

Special innovative construction and special glazing on the door isolates the oven, so the heat is kept inside, optimising energy consumption by stopping heat escaping from the oven cavity. This means that the cooker is even safer for the user, children and pets, and it also reduces ambient temperature changes arising from the cooking process.



DC+ System

Effective heat management

The DynamiCooling system efficiently cools the cooker exterior to prevent any damage caused by high temperature. In cookers with the DC+ system, the heat sensors regulate the cooling of the oven exterior walls until they reach a safe temperature of 60 °C.



SilverMatte Ultra resistant, ultra smooth coating

Enamel quality and type are exceptionally important for the cooker and its operation. SilverMatte is a highly resistant and strong material that can stand extreme heats. Free from micro pores, it coats oven cavity surfaces and baking trays, making them resistant to the highest temperatures. The coating of the interior supports heat reflection and provides additional insulation. Therefore, the oven interior always stays sterile and safe.



ChildLock The kitchen as a safe environment

ChildLock option is excellent for those who have children at home. This setting will prevent them from resetting any parameters or changing settings on display.

Special Programmes

Stay Warm Staying perfect for the latecomers

The StayWarm function keeps food at a constant temperature of 70°C until the time is right to serve the meal. The food retains its original flavour and temperature until it is served.

auto Defrost

In order to keep the food in perfect condition even after defrosting, it is very important to thaw it quickly and that the heat penetrates the core evenly and simultaneously. Safe defrosting is made possible by the defrost program. Use of a drip tray will also prevent undesired drops or spills of liquid. Place the frozen food on the oven rack in the middle of the oven. The drip tray placed into the lower guide will catch the dripping liquid.

Plate Warming Serve professional dishes in the comfort of your home

Warmed plates prevent the loss of flavour and ensure that food tastes every bit as good as it should: from soups to pastas and steamed vegetables. WarmPlate will keep your crockery at precisely the right temperature at 60°C. Enjoy professional service in the privacy of your home.

PERFECT TASTE WITH SPARK OF CREATIVITY

Gas Cooktop



Cooking like a chef can be simple. All it takes is a creative spark as Gorenje cooker with gas cooktop will take care of everything else. With its big surface, powerful burners and advanced

features, it offers support for your wildest cooking endeavours. Ignite your inspiration and surprise your loved ones with perfect home-made dishes.

*Cooktop covers as shown in the picture above are only available in select markets.



Big surface

Plenty of space for every pan or pot

Enlarged cooking surface (up to 20%) and longer distances between burners offer plenty of space for all sizes of pans and pots. Sleek and flat design allows easy sliding and using very

big pots without disturbance, with perfect stability for all your cooking adventures.



ChefBurners

More powerful and efficient cooking

New high-efficiency ChefBurners provide more efficient gas consumption and enable faster and eco-friendlier cooking. Different sizes of burners give you full flexibility, while their user-friendly positioning enables easy and safe cooking.



Cast iron ProGrids

Strong, stable and durable support

Massive and elegant cast iron ProGrids are extremely stable and resistant even to the highest temperatures. They bring superior stability, durability and user-friendly design to your kitchen.

FAST AND EFFICIENT COOKING, SIMPLE CLEANING

Induction cooktop

Induction hobs heat up twice as fast as HiLight hobs, which makes them comparatively more economical and safe. An induction hob only heats the bottom of the pan while the remaining hob surface stays cool and always safe to touch. Temperature is adjusted instantly, by a simple touch, limiting the danger of boiling over. With such a hob melted chocolate, sophisticated sauces and other temperature-sensitive masterpieces become just a simple task.



PowerBoost Cooking on fast-forward

PowerBoost function provides extreme heat intensity to the pot and significantly cuts cooking time. Boiling 2l of water now only takes about 5 minutes, which is extremely time-efficient. So with PowerBoost you save time, energy and money.

BridgeZone A simple plan for super-sized pots

The induction hob with two connecting zones simplifies cooking in large-sized pots. Two separate cooking zones are bridged to form one with just a simple touch. Perfect for preparing bigger pieces of food and sides simultaneously.



2 YEAR WARRANTY

- 65 l
- Icon: D-shaped door
- Icon: Hand pointing to control panel
- Icon: Fingerprint
- Icon: Three wavy lines

EIT 6565 XPD Advanced Line
Electric cooker with induction hob

A Energy Class

60 cm | 90 cm | DC+

Icons: Energy saving, document, light, XXL, induction, touch control, arrow, control panel

- Colour of brushed stainless steel / Control panel material: Glass
- Door material: Glass
- GentleClose door hinge



2 YEAR WARRANTY

- 65 l
- Icon: D-shaped door
- Icon: Hand pointing to control panel
- Icon: Three wavy lines

EIT 6451 WPD Advanced Line
Electric cooker with induction hob

A Energy Class

60 cm | 90 cm | DC

Icons: Energy saving, document, light, XXL, induction, touch control, arrow, control panel

- Colour: White / Control panel material: Varnished metal
- Door material: Glass
- GentleClose door hinge

Efficiency	<ul style="list-style-type: none"> - Usable oven volume: 65 l - Surface of the largest baking pan: 1316 cm² - HomeMADE® modelled on traditional wood-fired bread oven 	<ul style="list-style-type: none"> - Usable oven volume: 65 l - Surface of the largest baking pan: 1316 cm² - HomeMADE® modelled on traditional wood-fired bread oven
Control	<ul style="list-style-type: none"> - Touch control - Knob shape: Sinkable knobs - IconTouch 	<ul style="list-style-type: none"> - Touch control - Knob shape: Sinkable knobs - IconLed
Hob	<ul style="list-style-type: none"> - Induction hob - BoilControl, prevents boil-overs - Cooking surface: 4 induction heating zones - Left front: Ø 18.5 cm, 1.4/2 kW, - Right front: Ø 16.5 cm, 1.2/1.4 kW, - Left behind: Ø 18.5 cm, 1.2/1.4 kW, - Right behind: Ø 20.5 cm, 2/2.3 kW 	<ul style="list-style-type: none"> - Induction hob - BoilControl, prevents boil-overs - Cooking surface: 4 induction heating zones - Left front: Ø 18.5 cm, 1.4/2 kW, - Right front: Ø 16.5 cm, 1.2/1.4 kW, - Left behind: Ø 18.5 cm, 1.2/1.4 kW, - Right behind: Ø 20.5 cm, 2/2.3 kW
Oven	- Multisystem oven BigSpace - 65 l	- Multisystem oven BigSpace - 65 l
Heating types		
Features	<ul style="list-style-type: none"> - Interior light - Baking on different levels at the same time 	<ul style="list-style-type: none"> - Interior light - Baking on different levels at the same time
Equipment	<ul style="list-style-type: none"> - 2 Shallow enameled baking pans - 1 Deep enameled baking pan - 1 Wire shelf / 1 Meat Probe - Wire oven guides 	<ul style="list-style-type: none"> - 2 Shallow enameled baking pans - 1 Deep enameled baking pan - 1 Wire shelf / 1 Meat Probe - Wire oven guides
Safety	<ul style="list-style-type: none"> - Residual heat indicator - Safety control hob lock - ChildLock / Dynamic oven cooling - DC+ - Triple glazed oven door with one heat deflector (CoolDoor) 	<ul style="list-style-type: none"> - Residual heat indicator - Safety control hob lock - ChildLock / Dynamic oven cooling - DC - Triple glazed oven door with one heat deflector (CoolDoor)
EasyCleaning	<ul style="list-style-type: none"> - AquaClean function - SilverMatte / TouchFree Inox 	<ul style="list-style-type: none"> - AquaClean function - SilverMatte
Technical data	<ul style="list-style-type: none"> - Connection rating: 10300 W - Energy consumption: 0.82 kWh (venting), 0.92 kWh (conventional) - Dimensions (HxWxD): 90 x 60 x 60 cm - EAN code: 3838782108648 - Code: 730621 	<ul style="list-style-type: none"> - Connection rating: 10300 W - Energy consumption: 0.82 kWh (venting), 0.92 kWh (conventional) - Dimensions (HxWxD): 90 x 60 x 60 cm - EAN code: 3838782108655 - Code: 730622



EC 6451 WPB Essential Line
Electric cooker with glass ceramic hob



- Colour: White
- Control panel material: Varnished metal
- Door material: Glass
- GentleClose door hinge



E 6151 WA Essential Line
Electric cooker with solid-plate hob

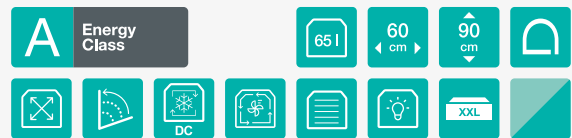

- Colour: White
- Control panel material: Varnished metal
- Door material: Glass
- GentleClose door hinge

Efficiency	<ul style="list-style-type: none"> - Usable oven volume: 65 l - Surface of the largest baking pan: 1316 cm² - HomeMADE® modelled on traditional wood-fired bread oven 	<ul style="list-style-type: none"> - Usable oven volume: 65 l - Surface of the largest baking pan: 1316 cm² - HomeMADE® modelled on traditional wood-fired bread oven
Control	<ul style="list-style-type: none"> - Knob shape: Sinkable knobs - IconLed 	<ul style="list-style-type: none"> - Knob shape: Ergonomic knobs
Hob	<ul style="list-style-type: none"> - Glass ceramic hob - Cooking surface: 2 HiLight cooking zones + 2 double HiLight cooking zones - Left front: Ø two ring 21/12 cm, 2.2 kW, - Right front: Ø 18 cm, 1.8 kW, - Left behind: Ø 14.5 cm, 1.2 kW, - Right behind: Ø two ring 18/12 cm, 1.7 kW 	<ul style="list-style-type: none"> - Electric hob - Cooking surface: 3 fast electric hobs + 1 standard hob with temperature restainer - Left front: Ø 22 cm, 2 kW, - Right front: Ø 14.5 cm, 1.5 kW, - Left behind: Ø 14.5 cm, 1.5 kW, - Right behind: Ø 18 cm, 2 kW
Oven	<ul style="list-style-type: none"> - Multisystem oven BigSpace - 65 l 	<ul style="list-style-type: none"> - Multisystem oven BigSpace - 65 l
Heating types		
Features	<ul style="list-style-type: none"> - Interior light - Baking on different levels at the same time 	<ul style="list-style-type: none"> - Interior light - Baking on different levels at the same time
Equipment	<ul style="list-style-type: none"> - 2 Shallow enameled baking pans - 1 Deep enameled baking pan - 1 Wire shelf - 1 Meat Probe - Wire oven guides 	<ul style="list-style-type: none"> - 2 Shallow enameled baking pans - 1 Deep enameled baking pan - 1 Wire shelf - Wire oven guides
Safety	<ul style="list-style-type: none"> - Residual heat indicator - Dynamic oven cooling - DC - Triple glazed oven door with one heat deflector (CoolDoor) 	<ul style="list-style-type: none"> - Dynamic oven cooling - DC - Double glazed oven door with one heat deflector (CompactDoor)
EasyCleaning	<ul style="list-style-type: none"> - AquaClean function - SilverMatte 	<ul style="list-style-type: none"> - AquaClean function - SilverMatte
Technical data	<ul style="list-style-type: none"> - Connection rating: 10000 W - Energy consumption: 0.82 kWh (venting), 0.92 kWh (conventional) - Dimensions (HxWxD): 90 x 60 x 60 cm - EAN code: 3838782108594 - Code: 730616 	<ul style="list-style-type: none"> - Connection rating: 10200 W - Energy consumption: 0.82 kWh (venting), 0.92 kWh (conventional) - Dimensions (HxWxD): 90 x 60 x 60 cm - EAN code: 3838782108631 - Code: 730620



GI 6121 WH

Gas cooker with gas hob

Essential Line



- Colour: White
- Control panel material: Varnished metal
- Door material: Glass
- GentleClose door hinge

Efficiency	<ul style="list-style-type: none"> - Usable oven volume: 60 l / SuperSize baking area - Surface of the largest baking pan: 1316 cm² - HomeMADE® modelled on traditional wood-fired bread oven
Control	<ul style="list-style-type: none"> - Knob shape: Ergonomic knobs - One-hand ignition device for hob and oven / Gas thermostat
Hob	<ul style="list-style-type: none"> - Gas hob / Burner frames number: 2 - Cooking surface: 1 auxiliary burner + 1 large burner + 2 standard burners - Left front: Ø 4.6 cm, 1 kW, - Right front: Ø 9.4 cm, 3 kW, - Left behind: Ø 6.9 cm, 1.9 kW, - Right behind: Ø 6.9 cm, 1.9 kW - Type of pan support: Enameled
Oven	<ul style="list-style-type: none"> - Gas oven - 60 l
Heating types	
Features	<ul style="list-style-type: none"> - Interior light
Equipment	<ul style="list-style-type: none"> - 1 Shallow enameled baking pan - 1 Deep enameled baking pan - 1 Wire shelf - Wire oven guides
Safety	<ul style="list-style-type: none"> - Thermoelectric fuse - Double glazed oven door with one heat deflector (CompactDoor) - Gas control
EasyCleaning	<ul style="list-style-type: none"> - AquaClean / SilverMatte - Removable flat oven inner door glass surface
Technical data	<ul style="list-style-type: none"> - Energy consumption gas oven: 6.01 MJ - Dimensions (HxWxD): 90 × 60 × 60 cm - EAN code: 3838782037870 - Product code: 728454



E 5120 SE Essential Line
Electric cooker with solid-plate hob



- Colour: Metallic grey
- Control panel material: Varnished metal
- Door material: Glass



E 5120 WE Essential Line
Electric cooker with solid-plate hob



- Colour: White
- Control panel material: Varnished metal
- Door material: Glass

Efficiency	<ul style="list-style-type: none"> - Usable oven volume: 68 l - Surface of the largest baking pan: 1260 cm² - HomeMADE® modelled on traditional wood-fired bread oven 	<ul style="list-style-type: none"> - Usable oven volume: 68 l - Surface of the largest baking pan: 1260 cm² - HomeMADE® modelled on traditional wood-fired bread oven
Control	- Knob shape: Ergonomic knobs	- Knob shape: Ergonomic knobs
Hob	<ul style="list-style-type: none"> - Electric hob - Cooking surface: 1 fast electric cooking zone + 3 standard electric cooking zones - Left front: Ø 18 cm, 2 kW, - Right front: Ø 14.5 cm, 1 kW, - Left behind: Ø 14.5 cm, 1 kW, - Right behind: Ø 18 cm, 1.5 kW 	<ul style="list-style-type: none"> - Electric hob - Cooking surface: 1 fast electric cooking zone + 3 standard electric cooking zones - Left front: Ø 18 cm, 2 kW, - Right front: Ø 14.5 cm, 1 kW, - Left behind: Ø 14.5 cm, 1 kW, - Right behind: Ø 18 cm, 1.5 kW
Oven	- Conventional - 68 l	- Conventional - 68 l
Heating types		
Features	- Interior light	- Interior light
Equipment	<ul style="list-style-type: none"> - 1 Deep enameled baking pan - 1 Wire shelf - Embossed guides 	<ul style="list-style-type: none"> - 1 Deep enameled baking pan - 1 Wire shelf - Embossed guides
Safety	- Double glazed oven door with one heat deflector (CompactDoor)	- Double glazed oven door with one heat deflector (CompactDoor)
EasyCleaning	<ul style="list-style-type: none"> - AquaClean - SilverMatte 	<ul style="list-style-type: none"> - AquaClean function - SilverMatte
Technical data	<ul style="list-style-type: none"> - Connection rating: 8300 W - Energy consumption: 0.85 kWh (conventional) - Dimensions (HxWxD): 85 × 50 × 59.4 cm - EAN code: 3838782037344 - Code: 591382 	<ul style="list-style-type: none"> - Connection rating: 8300 W - Energy consumption: 0.85 kWh (conventional) - Dimensions (HxWxD): 85 × 50 × 59.4 cm - EAN code: 3838782037382 - Code: 591383



GI 5121 SJ Essential Line
Gas cooker with gas hob

GI 5121 WJ Essential Line
Gas cooker with gas hob

A+ Energy Class

61 l | 50 cm | 85 cm

A+ Energy Class

61 l | 50 cm | 85 cm

- Colour: Metallic grey
- Control panel material: Varnished metal
- Door material: Glass

- Colour: White
- Control panel material: Varnished metal
- Door material: Glass

Efficiency	<ul style="list-style-type: none"> - Usable oven volume: 61 l - Surface of the largest baking pan: 1260 cm² - HomeMADE® modelled on traditional wood-fired bread oven: 	<ul style="list-style-type: none"> - Usable oven volume: 61 l - Surface of the largest baking pan: 1260 cm² - HomeMADE® modelled on traditional wood-fired bread oven:
Control	<ul style="list-style-type: none"> - Knob shape: Ergonomic knobs - Two hand ignition device for hob and oven - Gas thermostat 	<ul style="list-style-type: none"> - Knob shape: Ergonomic knobs - Two hand ignition device for hob and oven - Gas thermostat
Hob	<ul style="list-style-type: none"> - Gas hob - Burner frames number: 2 - Cooking surface: 1 auxiliary burner + 1 large burner + 2 standard burners - Left front: Ø 5.4 cm, 1 kW, - Right front: Ø 9.9 cm, 3 kW, - Left behind: Ø 7.4 cm, 1.9 kW, - Right behind: Ø 7.4 cm, 1.9 kW - Type of pan support: Enamelled two pieces 	<ul style="list-style-type: none"> - Gas hob - Burner frames number: 2 - Cooking surface: 1 auxiliary burner + 1 large burner + 2 standard burners - Left front: Ø 5.4 cm, 1 kW, - Right front: Ø 9.9 cm, 3 kW, - Left behind: Ø 7.4 cm, 1.9 kW, - Right behind: Ø 7.4 cm, 1.9 kW - Type of pan support: Enamelled two pieces
Oven	- Gas oven - 61 l	- Gas oven - 61 l
Heating types		
Features	<ul style="list-style-type: none"> - Interior light - Closed door grilling 	<ul style="list-style-type: none"> - Interior light - Closed door grilling
Equipment	<ul style="list-style-type: none"> - 1 Deep enameled baking pan - 1 Wire shelf - Embossed guides 	<ul style="list-style-type: none"> - 1 Deep enameled baking pan - 1 Wire shelf - Embossed guides
Safety	<ul style="list-style-type: none"> - Thermoelectric fuse - Double glazed oven door with one heat deflector (CompactDoor) - Gas control 	<ul style="list-style-type: none"> - Thermoelectric fuse - Double glazed oven door with one heat deflector (CompactDoor) - Gas control
EasyCleaning	- SilverMatte	- SilverMatte
Technical data	<ul style="list-style-type: none"> - Energy consumption gas oven: 5.25 MJ - Dimensions (HxWxD): 85 × 50 × 59.4 cm - EAN code: 3838782037443 - Code: 591381 	<ul style="list-style-type: none"> - Energy consumption gas oven: 5.25 MJ - Dimensions (HxWxD): 85 × 50 × 59.4 cm - EAN code: 3838782037412 - Code: 591380





THE COOL SIDE OF YOU

Vintage design, with a long list of colours to choose from, makes this refrigerator one of the highlights of your home. As a design item you can easily place it anywhere you like. Perhaps in your romantic kitchen, in your chic urban nest, even your funky loft. Each Retro refrigerator is striking, boasts optimal storage configurations, and all the features one would expect from a high-end appliance. Whatever the colour, these modern icons are an instant hit wherever they pop up.



IonAir with MultiFlow 360°

Ideal microclimate on every shelf

Advanced technology in the refrigerators emulates the natural process of ionization to keep the food fresh longer. Negatively charged ions generated by the appliance continuously refresh the air to mimic a natural microclimate, thus creating the ideal environment for fresh food. The MultiFlow 360° ventilation system evenly distributes the ionized air through 14 ventilation slots to maintain constant temperature on every shelf.



IonAir with DynamiCooling

Even temperature distribution in the refrigerator compartment

Advanced fan system with dynamic cooling evenly distributes the ionized air and equalizes the temperature throughout the entire refrigerator. Air enriched with extra negative ions mimics the natural microclimate that keeps the food fresh for longer. Moreover, any type of food can be placed on any shelf in the fridge as there are no temperature differences.



NoFrost Plus

No more tedious defrosting

One of the best cooling systems in the market, installed in the freezer compartment, prevents the accumulation of ice and frost to keep the power consumption low, while in the refrigerator compartment, it maintains an ideal microclimate for fresh food. Circulation of ionized air prevents the food from drying out and retains its vitamins and minerals.

AdaptTech

A refrigerator that recognizes your habits

This smart system was devised to maintain the optimum temperature in the refrigerator regardless of how frequently you open the door. When the door is opened, the temperature suddenly rises and the food is exposed to a thermal shock which in turn causes it to perish sooner. The refrigerator continuously monitors and analyzes the way you use it. Thus, it can predict when you will open the fridge door and just before you do, it decreases the temperature by 1 or 2 °C to make sure constant temperature is maintained and that the food stays fresh and full of nutrients.



LedLight

Well-arranged and efficient fridge

Power saving LED lighting fixtures in a form of strip are highly energy-efficient, have a notably longer useful life and consume less power.



PullOut shelves

Easy access to food

Sliding shelves for quick and easy access to food, which hold up to 22 kg of food.



SimpleSlide shelves

For both tall and short bottles

An especially practical mechanism which allows movement of shelves up and down.



FreshZone drawer

Fresh as if straight from nature

The drawer with the lowest temperature in the refrigerator is ideal for storing meat, fish, fruit, and vegetables. It will preserve the food's freshness, aroma, colour, and flavour for much longer.



ZeroZone drawer

Fresh as if straight from the sea

The drawer with temperature around 0 °C is ideal for storing fresh or marinated meat, fish and seafood. It extends the freshness of delicate food and keeps its natural juiciness and nutrients.



XtremeFreeze drawer

Freezing in a flash

Rapid freezing at extremely low temperatures. The shock-approach preserves all nutrients and the flavour of the food.



MultiBox

Multi-functional, practical box

The multi-purpose bin with a cover in the refrigerator door can be used for storing cheese, onions, and other food with a pungent smell. It keeps the food fresh and protects it from drying, while the silicone cover can be used as an egg or ice tray.



FastFreeze

Rapid freezing

Function inside the freezer for fast freezing of food, perfect for restocking.



CrispZone drawer featuring HumidityControl

Just like garden-fresh

CrispZone is one of the largest fruit and vegetables bins in the market. Low temperature and the option to adjust the humidity extend the freshness of your produce.



FrostLess

Less ice, more energy saving

Improved insulation effectively reduces the accumulation of frost on the food and ice in the appliance interior. This means less tedious defrosting and a lower electricity bill.



Top energy efficiency

All Gorenje refrigerators are highly energy-efficient. Excellent thermal insulation and door sealing and electronic or mechanical control efficiently reduce power consumption. Gorenje A+++ refrigerators verified by the Energy Saving Trust cost less than £2 to run every month, or just £3 for A++.

(Based on ORB153, RF60309, ORK193, ONRK193. Figures are based on the EU Energy Label energy consumption. Average electricity price of 13.86p/kWh. Correct as of January 2016).



Inverter Compressor

Steady, silent, and durable

InverterCompressor are more silent, have a longer useful life and they are more economical compared to those with a conventional compressor. Whenever the temperature in the fridge interior rises as a result of door opening, the inverter compressor delivers rapid and effective cooling to prevent the food from spoiling.



EcoMode

Energy savings

In case of prolonged absence, the fridge can be set to operate in power-saving mode as the door is closed all the time.



SuperCool

Rapid cooling after weekly shopping

The intensive cooling function drops the refrigerator temperature by nearly a half of its usual. Ideal for rapid cooling of food after major shopping trips.



Fan

Fan assisted cooling

A fan propels the air to make sure the temperature is even throughout the refrigerator. This improves cooling and prevents accumulation of condensate, thus maintaining optimum environment for lasting freshness of all types of food.



ONRK 193 C Gorenje Retro Collection Freestanding No Frost fridge freezer

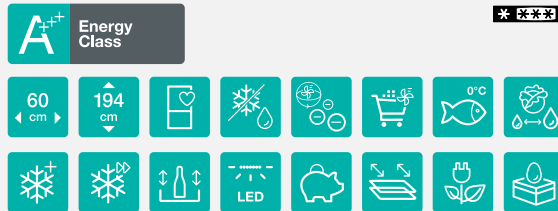

- Colour: Cream
- Right door opening
- Door material: Plastic
- Climate class: SN, ST, N, T

Efficiency	<ul style="list-style-type: none"> - Inverter compressor - Total gross/net volume: 334 / 307 l - Capacity of cooling compartment: gross/net: 231 / 222 l - Capacity of freezer compartment: gross/net: 103 / 85 l - Freezing capacity in 24 hours: 8 kg / 24h - Power cut safe time: 18 h
Control	<ul style="list-style-type: none"> - Electronic control behind the door - Type of display: LED - Sound alarm for open door - Digital temperature indicator for freezer and refrigerator - Sound and visual signal for high temperature in refrigerator: white signal
Features	<ul style="list-style-type: none"> - IonAir with MultiFlow 360 ° - AdaptTech cooling: Memorizing intelligent system - NoFrost Plus / SuperCool / FastFreeze / Saving programme EcoMode - XtremeFreeze: very intensive freezing in the upper freezer drawer
Equipment of refrigerator	<ul style="list-style-type: none"> - Egg/Ice bin: Egg/Ice bin: 1 x 7 - SimpleSlide height adjustable door shelves: 2 - Type of interior light: LED strip on the ceiling - 4 glass shelves - Bottle rack / Bottle shelf with fixed trap - MultiBox for butter and cheese - CrispZone drawer featuring HumidityControl / ZeroZone drawer
Equipment of freezer	<ul style="list-style-type: none"> - 1 XXL SpaceBox drawer - 2 drawers for freezing - 2 glass shelves
Technical data	<ul style="list-style-type: none"> - Energy consumption kWh/24h: 0.46 kWh - Level of noise (max.): 38 dB(A)re 1 pW - Product dimensions (HxWxD): 194 × 60 × 66.9 cm - EAN code: 3838942104954 - Product code: 538883



ONRK 193 R
 - Colour: Burgundy
 - EAN code: 3838942104923
 - Product code: 538880



ONRK 193 BK
 - Colour: Black
 - EAN code: 3838942104930
 - Product code: 538881



ONRK 193 BL
 - Colour: Baby Blue
 - EAN code: 3838942104947
 - Product code: 538882



ORK 193 R Gorenje Retro Collection
Freestanding fridge freezer



- Colour: Burgundy
- Right door opening
- Door material: Plastic
- Climate class: SN, ST, N, T

Efficiency	<ul style="list-style-type: none"> - 1 compressor - Total gross/net volume: 326 / 322 l - Capacity of cooling compartment: gross/net: 229 / 227 l - Capacity of freezer compartment: gross/net: 97 / 95 l - Freezing capacity in 24 hours: 4,5 kg / 24h - Power cut safe time: 30 h
Control	<ul style="list-style-type: none"> - Electronic control behind the door
Features	<ul style="list-style-type: none"> - AdaptTech cooling: Memorizing intelligent system - FrostLess: Less ice building in the freezer - IonAir with DynamiCooling - FastFreeze
Equipment of refrigerator	<ul style="list-style-type: none"> - Egg/Ice bin: Egg/Ice bin: 1 x 7 - SimpleSlide height adjustable door shelves: 2 - Type of interior light: LED strip on the ceiling - 4 glass shelves - Bottle rack - Bottle shelf with fixed trap - MultiBox for butter and cheese - CrispZone drawer featuring HumidityControl - FreshZone drawer
Equipment of freezer	<ul style="list-style-type: none"> - 1 XXL SpaceBox drawer - 2 drawers for freezing - 2 glass shelves
Technical data	<ul style="list-style-type: none"> - Energy consumption kWh/24h: 0.423 kWh - Level of noise (max.): 40 dB(A)re 1 pW - Product dimensions (HxWxD): 194 × 60 × 66.9 cm - EAN code: 3838942093326 - Product code: 528545



ORK 193 C
- Colour: Cream
- EAN code: 3838942093333
- Product code: 528546



ORK 193 X
Colour: Silver
- EAN code: 3838942092596
- Product code: 527606



ORK 193 BK
- Colour: Black
- EAN code: 3838942093340
- Product code: 528547



ORK 193 RD
- Colour: Fiery Red
- EAN code: 3838942092589
- Product code: 527664



ORK 193 O
- Colour: Juicy Orange
- EAN code: 3838942092602
- Product code: 527678



ORK 193 BL
- Colour: Baby Blue
- EAN code: 3838942092923
- Product code: 527688



ORK 193 BK-L Gorenje Retro Collection Freestanding fridge freezer



- Colour: Black
- Left door opening
- Door material: Plastic
- Climate class: SN, ST, N, T

Efficiency	<ul style="list-style-type: none"> - 1 compressor - Total gross/net volume: 326 / 322 l - Capacity of cooling compartment: gross/net: 229 / 227 l - Capacity of freezer compartment: gross/net: 97 / 95 l - Freezing capacity in 24 hours: 4,5 kg / 24h - Power cut safe time: 30 h
Control	<ul style="list-style-type: none"> - Electronic control behind the door
Features	<ul style="list-style-type: none"> - AdaptTech cooling: Memorizing intelligent system - FrostLess: Less ice building in the freezer - IonAir with DynamiCooling - FastFreeze
Equipment of refrigerator	<ul style="list-style-type: none"> - Egg/Ice bin: Egg/Ice bin: 1 x 7 - SimpleSlide height adjustable door shelves: 2 - Type of interior light: LED strip on the ceiling - 4 glass shelves - Bottle rack - Bottle shelf with fixed trap - MultiBox for butter and cheese - CrispZone drawer featuring HumidityControl - FreshZone drawer
Equipment of freezer	<ul style="list-style-type: none"> - 1 XXL SpaceBox drawer - 2 drawers for freezing - 2 glass shelves
Technical data	<ul style="list-style-type: none"> - Energy consumption kWh/24h: 0.423 kWh - Level of noise (max.): 40 dB(A)re 1 pW - Product dimensions (HxWxD): 194 x 60 x 66.9 cm - EAN code: 3838942087677 - Product code: 521885



ORK 193 C-L
 - Colour: Cream
 - EAN code: 3838942087684
 - Product code: 521899



ORK 193 R-L
 - Colour: Burgundy
 - EAN code: 3838942087660
 - Product code: 521884



RF 60309 OC Gorenje Retro Collection
Freestanding fridge freezer



- Colour: Cream
- Right door opening
- Door material: Plastic
- Climate class: SN, ST, N, T

Efficiency	<ul style="list-style-type: none"> - 1 compressor - Total gross/net volume: 296 / 294 l - Capacity of cooling compartment: gross/net: 231 / 229 l - Capacity of freezer compartment: gross/net: 65 / 65 l - Freezing capacity in 24 hours: 4.5 kg / 24h - Power cut safe time: 22 h
Control	<ul style="list-style-type: none"> - Mechanical control
Features	<ul style="list-style-type: none"> - Fan-assisted cooling in fridge - SuperCool - FastFreeze
Equipment of refrigerator	<ul style="list-style-type: none"> - Type of interior light: LED bulb on side - 4 glass shelves - Bottle rack - Dairy shelf - Flexible egg tray (12x) - Deep door two-partition bottle shelf with fixed trap - Large crisper pan for vegetables and fruit
Equipment of freezer	<ul style="list-style-type: none"> - 1 wire shelf in freezer department - 1 compartment with door for frozen food - 1 ice tray
Technical data	<ul style="list-style-type: none"> - Energy consumption kWh/24h: 0.583 kWh - Level of noise (max.): 39 dB(A)re 1 pW - Product dimensions (HxWxD): 173.4 x 60 x 64 cm - EAN code: 3838942899386 - Product code: 444708



RF 60309 OR
- Colour: Burgundy
- EAN code: 3838942899256
- Product code: 444721



RF 60309 OX
- Colour: Silver
- EAN code: 3838942028250
- Product code: 481864



RF 60309 OBK
- Colour: Black
- EAN code: 3838942899379
- Product code: 444709



RF 60309 OC-L Gorenje Retro Collection Freestanding fridge freezer



- Colour: Cream
- Left door opening
- Door material: Plastic
- Climate class: SN, ST, N, T

Efficiency	<ul style="list-style-type: none"> - 1 compressor - Total gross/net volume: 296 / 294 l - Capacity of cooling compartment: gross/net: 231 / 229 l - Capacity of freezer compartment: gross/net: 65 / 65 l - Freezing capacity in 24 hours: 4.5 kg / 24h - Power cut safe time: 22 h
Control	<ul style="list-style-type: none"> - Mechanical control
Features	<ul style="list-style-type: none"> - Fan-assisted cooling in fridge - SuperCool - FastFreeze
Equipment of refrigerator	<ul style="list-style-type: none"> - Type of interior light: LED bulb on side - 4 glass shelves - Bottle rack - Dairy shelf - Flexible egg tray (12x) - Deep door two-partition bottle shelf with fixed trap - Large crisper pan for vegetables and fruit
Equipment of freezer	<ul style="list-style-type: none"> - 1 wire shelf in freezer department - 1 compartment with door for frozen food - 1 ice tray
Technical data	<ul style="list-style-type: none"> - Energy consumption kWh/24h: 0.583 kWh - Level of noise (max.): 39 dB(A)re 1 pW - Product dimensions (HxWxD): 173.4 × 60 × 64 cm - EAN code: 3838942898716 - Product code: 444776



ORB 153 O Gorenje Retro Collection
Freestanding refrigerator with IceBox



- Colour: Juicy Orange
- Right door opening
- Door material: Plastic
- Climate class: SN, ST, N, T

Efficiency	<ul style="list-style-type: none"> - 1 compressor - Total gross/net volume: 260 / 254 l - Capacity of cooling compartment: gross/net: 235 / 229 l - Capacity of freezer compartment: gross/net: 25 / 25 l - Freezing capacity in 24 hours: 2 kg / 24h - Power cut safe time: 17 h
Control	<ul style="list-style-type: none"> - Mechanical control
Features	<ul style="list-style-type: none"> - IonAir with DynamiCooling
Equipment of refrigerator	<ul style="list-style-type: none"> - Egg/Ice bin: Egg/Ice bin: 1 x 7 - SimpleSlide height adjustable door shelves: 3 - Type of interior light: LED strip by side - 4 glass shelves - Bottle rack - Bottle shelf with fixed trap - MultiBox for butter and cheese - CrispZone drawer featuring HumidityControl - FreshZone drawer
Equipment of freezer	<ul style="list-style-type: none"> - 1 compartment with door for frozen food
Technical data	<ul style="list-style-type: none"> - Energy consumption kWh/24h: 0.339 kWh - Level of noise (max.): 40 dB(A)re 1 pW - Product dimensions (HxWxD): 154 x 60 x 66.9 cm - EAN code: 3838942092695 - Product code: 527317



ORB 153 BL
- Colour: Baby Blue
- EAN code: 3838942094903
- Product code: 530640



ORB 153 C
- Colour: Cream
- EAN code: 3838942093357
- Product code: 528548



ORB 153 R
- Colour: Burgundy
- EAN code: 3838942094910
- Product code: 530642



ORB 153 RD
- Colour: Fiery Red
- EAN code: 3838942093371
- Product code: 528605



ORB 153 BK
- Colour: Black
- EAN code: 3838942093364
- Product code: 528602



ORB 153 X
- Colour: Silver
- EAN code: 3838942092701
- Product code: 527319



ORB 153 C-L Gorenje Retro Collection Freestanding refrigerator with IceBox



- Colour: Cream
- Left door opening
- Door material: Plastic
- Climate class: SN, ST, N, T

Efficiency	<ul style="list-style-type: none"> - 1 compressor - Total gross/net volume: 260 / 254 l - Capacity of cooling compartment: gross/net: 235 / 229 l - Capacity of freezer compartment: gross/net: 25 / 25 l - Freezing capacity in 24 hours: 2 kg / 24h - Power cut safe time: 17 h
Control	- Mechanical control
Features	- IonAir with DynamiCooling
Equipment of refrigerator	<ul style="list-style-type: none"> - Egg/Ice bin: Egg/Ice bin: 1 x 7 - SimpleSlide height adjustable door shelves: 3 - Type of interior light: LED strip by side - 4 glass shelves - Bottle rack - Bottle shelf with fixed trap - MultiBox for butter and cheese - CrispZone drawer featuring HumidityControl - FreshZone drawer
Equipment of freezer	- 1 compartment with door for frozen food
Technical data	<ul style="list-style-type: none"> - Energy consumption kWh/24h: 0.339 kWh - Level of noise (max.): 40 dB(A)re 1 pW - Product dimensions (HxWxD): 154 x 60 x 66.9 cm - EAN code: 3838942087226 - Product code: 521303



ORB 153 BL-L
 - Colour: Baby Blue
 - EAN code: 3838942092671
 - Product code: 527315



ORB 153 BK-L
 - Colour: Black
 - EAN code: 3838942086618
 - Product code: 521302



GORENJE RETRO SPECIAL EDITION FRIDGE

Inspired by the famous
Volkswagen van



Official
Licensed Product



OBRB 153 R Gorenje Retro Collection Freestanding refrigerator with IceBox

A⁺⁺ Energy Class



60 cm

154 cm



- Colour: Burgundy
- Right door opening
- Door material: Plastic
- Climate class: SN, ST, N, T



- OBRB 153 BL**
- Colour: Baby Blue
 - EAN code: 3838782024207
 - Product code: 590938

Efficiency	<ul style="list-style-type: none"> - 1 compressor - Total gross/net volume: 260 / 254 l - Capacity of cooling compartment: gross/net: 235 / 229 l - Capacity of freezer compartment: gross/net: 25 / 25 l - Freezing capacity in 24 hours: 2 kg / 24h - Power cut safe time: 17 h
Control	<ul style="list-style-type: none"> - Mechanical control
Features	<ul style="list-style-type: none"> - IonAir with DynamiCooling
Equipment of refrigerator	<ul style="list-style-type: none"> - Egg/Ice bin: Egg/Ice bin: 1 x 7 - SimpleSlide height adjustable door shelves: 3 - Type of interior light: LED strip by side - 4 glass shelves - Bottle rack - Bottle shelf with fixed trap - MultiBox for butter and cheese - CrispZone drawer featuring HumidityControl - FreshZone drawer
Equipment of freezer	<ul style="list-style-type: none"> - 1 compartment with door for frozen food:
Technical data	<ul style="list-style-type: none"> - Energy consumption kWh/24h: 0.339 kWh - Level of noise (max.): 40 dB(A)re 1 pW - Product dimensions (HxWxD): 154 x 60 x 66.9 cm - EAN code: 3838782024313 - Product code: 590939

GUARDIANS OF VITAMINS

Cooling Appliances

Gorenje refrigerators, freezers and fridge freezers are the hub of every kitchen. They are tasked with a simple mission – make sure your favourite food is always available. But Gorenje cooling appliances can do much more. They feature smart technologies to mimic the conditions similar to those found in nature, which keeps the food fresh, tasty, and full of vital nutrients for longer. On the inside, they are thoughtfully organized to allow the user optimum view and plenty of space for storage of even larger amounts. On the outside, their superior design introduces a welcome visual accent to any home. Last but not least, they are notoriously charming with their silent and economical operation, and convincing durability.







IonAir with the MultiFlow 360° function

Ideal microclimate on every shelf

Advanced technology in the refrigerators emulates the natural process of ionization to keep the food fresh longer. Negatively charged ions generated by the appliance continuously refresh the air to mimic a natural microclimate, thus creating the ideal environment for fresh food. The MultiFlow 360° ventilation system evenly distributes the ionized air through 14 ventilation slots to maintain constant temperature on every shelf.



Natural microclimate inside refrigerator

Bad food storage





AdaptTech

A refrigerator that recognizes your habits

This smart system was devised to maintain the optimum temperature in the refrigerator regardless of how frequently you open the door. When the door is opened, the temperature suddenly rises and the food is exposed to a thermal shock which in turn causes it to perish sooner. The refrigerator

continuously monitors and analyzes the way you use it. Thus, it can predict when you will open the fridge door and just before you do, it decreases the temperature by 1 or 2 °C to make sure constant temperature is maintained and that the food stays fresh and full of nutrients.

Temperature [°C]

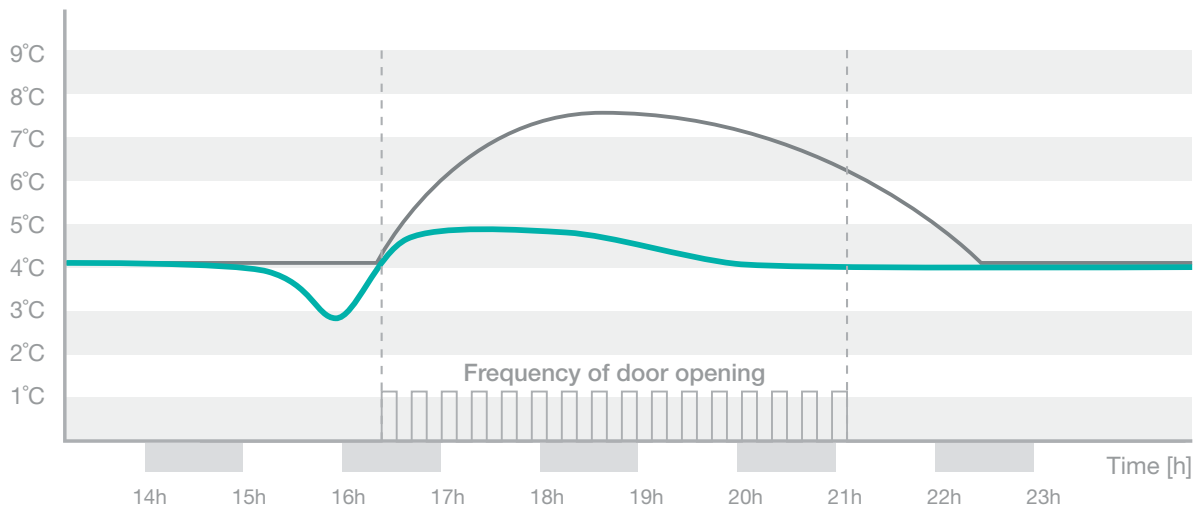

— Line of temperature oscillations in a regular refrigerator

— Line of temperature oscillations in refrigerator with AdaptTech technology



NoFrost Plus

No more tedious defrosting

One of the best cooling systems in the market, installed in the freezer compartment, prevents the accumulation of ice and frost to keep the power consumption low, while in the refrigerator compartment, it maintains an ideal microclimate for fresh food. Circulation of ionized air prevents the food from drying out and retains its vitamins and minerals.



The big party can start

ConvertActive fridge freezer The big party can start

The fridge freezer only takes a simple press of a button to turn the freezer compartment into a refrigerator compartment, affording more space for storage of snacks or beverages.



NRC 6192 TXUK



CrispActive drawer with the VitaLight

The fruit and vegetables bin with the special VitaLight extends the freshness of the food. A spectrum of orange light slows down the natural process of ripening in the fruits and vegetables to retain vitamins and minerals.



FreshActive drawer

This drawer is ideal for storing meat, fish, and seafood. The temperature is a few degrees lower than in the remaining part of the refrigerator compartment, which considerably extends its freshness.



CrispZone drawer featuring HumidityControl Just like garden-fresh

CrispZone is one of the largest fruit and vegetable bins in the market. Low temperature and the option to adjust the humidity extend the freshness of your produce.



ZeroZone drawer Fresh as if straight from the sea

Keeping the temperature around 0 °C, this drawer is ideal for storing fresh or marinated meat, fish and seafood. It extends the freshness of delicate food and keeps its natural juiciness and nutrients.



XtremeFreeze drawer Freezing in a flash

When this function is activated, the food placed in a special drawer in the freezer compartment will be frozen in half the usual time. Rapid freezing at extremely low temperatures below -30 °C leads to formation of microcrystals that, unlike in case of slow freezing, do not damage the cellular structure of the food. The shock-approach to freezing thus preserves all nutrients and the flavour of the food. After approximately 1 day, the function is automatically switched off and the temperature in the drawer returns to the initial setting.



XXL SpaceBox Enough space to store a turkey

This freezer compartment drawer is the largest in the appliance and it is ideal for storing large items like a turkey, several pizzas, or even cakes.





SlotIn

Owing to the functionality of opening the refrigerator door at a right angle, all shelves and bins can be fully pulled out. This solution is ideal for refrigerators placed against a side wall, or adjacent to a countertop or another appliance.



SuperCool

The intensive cooling function drops the refrigerator temperature to 3 °C, which is lower than usual by nearly a half. Combined with large refrigerator compartment volume, this temperature is ideal for rapid cooling of food after major shopping trips. After six hours, the function is switched off automatically and the refrigerator compartment temperature returns to the initial setting.



PullOut shelves

Shelves on extendible guides allow quick and easy access to food at the back of the fridge. The tempered glass shelves are highly durable and will carry up to 22 kilograms of food.



FrostLess

Improved insulation effectively reduces the accumulation of frost on the food and ice in the appliance interior. This means less tedious defrosting and a lower electricity bill.



FastFreeze

The FastFreeze function freezes the food at -24 °C to preserve most of the minerals in the food. After approximately 2 days, the function is switched off automatically and the freezer compartment temperature returns to the initial setting.



MultiBox

The multi-purpose bin with a cover in the refrigerator door can be used for storing cheese, onions, and other food with a pungent smell. It keeps the food fresh and protects it from drying, while the silicone cover can be used as an egg or ice tray.



SimpleSlide shelves

Height-adjustable shelves in the refrigerator door can be easily moved up or down to accommodate up to 5 kilograms of food of different shapes or sizes.



IonAir with DynamiCooling

Advanced fan system with dynamic cooling evenly distributes the ionized air and equalizes the temperature throughout the entire refrigerator. Air enriched with extra negative ions mimics the natural microclimate that keeps the food fresh for longer. Moreover, the any type of food can be placed on any shelf in the fridge as there are not temperature differences.



LedLight

LED lighting in refrigerators provides excellent and highly efficient illumination. Its useful life is thirty times as long as that of conventional light bulbs, and it saves up to ten times as much power.



EcoMode

In case of prolonged absence, the fridge can be set to operate in power-saving mode as the door is closed all the time.



Top energy efficiency

All Gorenje refrigerators are highly energy-efficient. Excellent thermal insulation and door sealing and electronic or mechanical control efficiently reduce power consumption. Gorenje A++ refrigerators verified by the Energy Saving Trust cost less than £3 to run every month.

(Based on NRC6192TXUK and NRK6192M. Figures are based on the EU Energy Label energy consumption. Average electricity price of 13.86p/kWh. Correct as of January 2016).

FREESTANDING FRIDGE FREEZERS

SUPERIOR line

ESSENTIAL line

ConvertActive

(available only in 1.85 m models)

OPERATION	NoFrost cooling
Mechanical	
Electronic	
Electronic LED display behind doors	
Electronic LED display on doors	●
AdaptTech	●
IonAir Dynamic Cooling	
IonAir Multiflow 360°	●
ECO mode	●
SlotIn	●
EQUIPMENT	
Simple Slide	●
PullOut shelves	●
CrispActive with VitaLight	●
FreshActive ↻	●
ZeroZone	●
MultiBox	●
XXL SpaceBox	●
Bottle rack	●
LED light	●
ALU profile shelves	●
ALU profile on drawers	●
ALU profile on door shelves	●
HANDLE TYPE	
Plastic	
Metal	●
FREEZING SYSTEM	
Fast Freeze	●
Xtreme Freeze	●

OPERATION	FrostLess cooling	NoFrost cooling
Mechanical	●	
Electronic		●
Electronic LED display behind doors		
Electronic LED display on doors		
AdaptTech		
IonAir Dynamic Cooling		
IonAir Multiflow 360°		●
ECO mode		●
SlotIn	●	●
EQUIPMENT		
SimpleSlide	●	●
PullOut shelves	●	●
CrispZone with HumidityControl	●	●
FreshZone	●	●
ZeroZone		
MultiBox		
XXL SpaceBox	●	●
Bottleholder	●	●
LED light	●	●
ALU profile shelves		
ALU profile on drawers		
ALU profile on door shelves		
HANDLE TYPE		
Plastic	●	
Metal		●
FREEZING SYSTEM		
FastFreeze		●
XtremeFreeze		

FREESTANDING FRIDGE FREEZERS



COLOUR edition - NRK6192M....

	NoFrost cooling
OPERATION	
Mechanical	
Electronic	
Electronic LED display behind doors	
Electronic LED display on doors	●
AdaptTech	●
IonAir Dynamic Cooling	
IonAir Multiflow 360°	●
ECO mode	
SlotIn	●
EQUIPMENT	
SimpleSlide	●
PullOut shelves	●
CrispZone with HumidityControl	●
FreshZone	●
ZeroZone	
MultiBox	●
XXL SpaceBox	●
Bottleholder	●
LED light	●
ALU profile shelves	●
ALU profile on drawers	●
ALU profile on door shelves	
HANDLE TYPE	
Plastic	
Metal	●
FREEZING SYSTEM	
FastFreeze	●
XtremeFreeze	

FREESTANDING FRIDGE FREEZERS

FREESTANDING REFRIGERATORS



COLOUR edition - RK 6192 E...



ESSENTIAL line

	FrostLess cooling
OPERATION	
Mechanical	●
Electronic	
Electronic LED display behind doors	
Electronic LED display on doors	
AdaptTech	
IonAir Dynamic Cooling	
ECO mode	
SlotIn	●
SuperCool	
EQUIPMENT	
Simple Slide	●
PullOut shelves	●
CrispZone with HumidityControl	●
CrispZone x 1	●
FreshZone x 2	
MultiBox	
Bottle rack	●
LED light	●
ALU profile shelves	●
ALU profile on drawers	
ALU profile on door shelves	
HANDLE TYPE	
Metal	●
Plastic	
FREEZING SYSTEM	
Fast Freeze	
Xtreme Freeze	

	Cooler
OPERATION	
Mechanical	●
Electronic	
Electronic LED display behind doors	
Electronic LED display on doors	
AdaptTech	
IonAir Dynamic Cooling	●
ECO mode	●
SlotIn	●
SuperCool	
EQUIPMENT	
Simple Slide	●
PullOut shelves	●
CrispZone with HumidityControl	●
CrispZone x 1	●
FreshZone x 2	●
MultiBox	
Bottle rack	●
LED light	●
ALU profile shelves	
ALU profile on drawers	
ALU profile on door shelves	
HANDLE TYPE	
Metal	●
Plastic	

FREESTANDING FREEZERS



ESSENTIAL line

	NoFrost Freezer
OPERATION	
Mechanical	
Electronic	●
Electronic LED display behind doors	
Electronic LED display on doors	
ECO mode	●
SlotIn	●
EQUIPMENT	
FastFreeze	●
Freezer door (flap) x 1	●
Upper freezer drawer x 2	●
SpaceBox x 3	●
Bottom freezer drawer x 1	●
LED light	●
MultiBox	
Ice rack	●
ALU profile on drawers	
HANDLE TYPE	
Metal	●
Plastic	



NRC 6192 TXUK Superior Line Freestanding Convert Active fridge freezer

NRK 6191 GXUK Essential Line Freestanding NoFrost fridge freezer

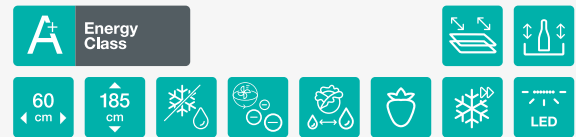
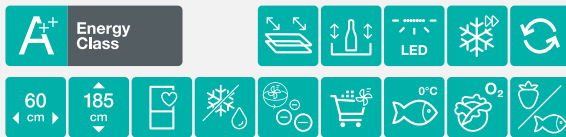

- Colour: Stainless steel
- Reversible door opening
- Door material: Genuine Inox with TouchFree coating
- Climate class: SN, ST, N, T

- Colour: Stainless steel
- Reversible door opening
- Door material: Genuine Inox with TouchFree coating
- Climate class: ST, N, T

Efficiency	<ul style="list-style-type: none"> - 1 compressor - Total gross/net volume: 329 / 307 l - Capacity of cooling compartment: gross/net: 231 / 222 l - Capacity of freezer compartment: gross/net: 98 / 85 l - Freezing capacity in 24 hours: 12 kg / 24h - Power cut safe time: 18 h 	<ul style="list-style-type: none"> - 1 compressor - Total gross/net volume: 325 / 307 l - Capacity of cooling compartment: gross/net: 230 / 222 l - Capacity of freezer compartment: gross/net: 95 / 85 l - Freezing capacity in 24 hours: 5 kg / 24h - Power cut safe time: 21 h
Control	<ul style="list-style-type: none"> - Electronic control on door - Type of display: LED - Sound alarm for open door - Sound and visual signal for high temperature in refrigerator: white signal 	<ul style="list-style-type: none"> - Electronic control behind the door
Features	<ul style="list-style-type: none"> - ConvertActive: Converts freezer into refrigerator - IonAir with MultiFlow 360 ° - AdaptTech cooling: Memorizing intelligent system - Slot-in: possibility to put the appliance into the kitchen niche 60 cm - NoFrost Plus / SuperCool / FastFreeze - Saving programme EcoMode - XtremeFreeze: very intensive freezing in the upper freezer drawer 	<ul style="list-style-type: none"> - IonAir with MultiFlow 360 ° - Slot-in: possibility to put the appliance into the kitchen niche 60 cm - NoFrost Plus - FastFreeze - Saving programme EcoMode
Equipment of refrigerator	<ul style="list-style-type: none"> - Egg/Ice bin: 1 x 7 - SimpleSLide height adjustable door shelves: 2 - Type of interior light: LED strip on the ceiling - 4 glass shelves - Bottle rack - Bottle shelf with fixed trap - MultiBox for butter and cheese - CrispActive drawer with VitaLight with HumidityControl - FreshActive drawer / ZeroZone drawer 	<ul style="list-style-type: none"> - Egg/Ice bin: 1 x 7 - SimpleSLide height adjustable door shelves: 2 - Type of interior light: LED strip on the ceiling - 4 glass shelves - Bottle rack - Bottle shelf with fixed trap - FreshZone drawer - CrispZone drawer featuring HumidityControl
Equipment of freezer	<ul style="list-style-type: none"> - 1 XXL SpaceBox drawer for freezing - 2 drawers for freezing - 2 glass shelves 	<ul style="list-style-type: none"> - 1 XXL SpaceBox drawer for freezing - 2 drawers for freezing - 2 glass shelves
Technical data	<ul style="list-style-type: none"> - Energy consumption kWh/24h: 0.643 kWh - Level of noise (max.): 42 dB(A)re 1 pW - Product dimensions (HxWxD): 185 × 60 × 64 cm - EAN code: 3838942092039 - Product code: 527329 	<ul style="list-style-type: none"> - Energy consumption kWh/24h: 0.819 kWh - Level of noise (max.): 42 dB(A)re 1 pW - Product dimensions (HxWxD): 185 × 60 × 64 cm - EAN code: 3838942001499 - Product code: 469425

 5
YEAR
WARRANTY

NRK 6191 GWUK Essential Line

Freestanding NoFrost fridge freezer

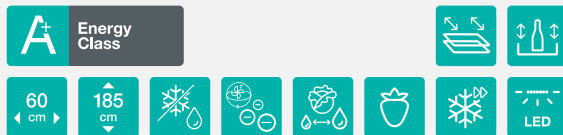

- Colour: White
- Reversible door opening
- Door material: Steel sheet
- Climate class: ST, N, T

Efficiency	<ul style="list-style-type: none"> - 1 compressor - Total gross/net volume: 325 / 307 l - Capacity of cooling compartment: gross/net: 230 / 222 l - Capacity of freezer compartment: gross/net: 95 / 85 l - Freezing capacity in 24 hours: 5 kg / 24h - Power cut safe time: 21 h
Control	<ul style="list-style-type: none"> - Electronic control behind the door
Features	<ul style="list-style-type: none"> - IonAir with MultiFlow 360 ° - Slot-in: possibility to put the appliance into the kitchen niche 60 cm - NoFrost Plus - FastFreeze - Saving programme EcoMode
Equipment of refrigerator	<ul style="list-style-type: none"> - Egg/Ice bin: 1 x 7 - SimpleSLide height adjustable door shelves: 2 - Type of interior light: LED strip on the ceiling - 4 glass shelves - Bottle rack - Bottle shelf with fixed trap - FreshZone drawer - CrispZone drawer featuring HumidityControl
Equipment of freezer	<ul style="list-style-type: none"> - 1 XXL SpaceBox drawer for freezing - 2 drawers for freezing - 2 glass shelves
Technical data	<ul style="list-style-type: none"> - Energy consumption kWh/24h: 0.819 kWh - Level of noise (max.): 42 dB(A)re 1 pW - Product dimensions (HxWxD): 185 x 60 x 64 cm - EAN code: 3838942936401 - Product code: 427796



NRK 6192 MBKUK Colour Edition
Freestanding NoFrost fridge freezer

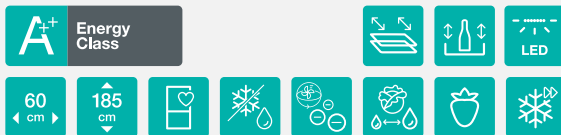

- Colour: Black
- Reversible door opening
- Door material: Steel sheet
- Climate class: SN, ST, N, T

Efficiency	<ul style="list-style-type: none"> - 1 compressor - Total gross/net volume: 329 / 307 l - Capacity of cooling compartment: gross/net: 231 / 222 l - Capacity of freezer compartment: gross/net: 98 / 85 l - Freezing capacity in 24 hours: 5 kg / 24h - Power cut safe time: 18 h
Control	<ul style="list-style-type: none"> - Electronic control on door - Type of display: LED - Sound alarm for open door - Digital temperature indicator for refrigerator - Sound and visual signal for high temperature in refrigerator: white signal
Features	<ul style="list-style-type: none"> - IonAir with MultiFlow 360 ° - AdaptTech cooling: Memorizing intelligent system - Slot-in: possibility to put the appliance into the kitchen niche 60 cm - NoFrost Plus - FastFreeze
Equipment of refrigerator	<ul style="list-style-type: none"> - Egg/Ice bin: Egg/Ice bin: 1 x 7 - SimpleSlide height adjustable door shelves: 2 - Type of interior light: LED strip on the ceiling - 4 glass shelves - Bottle rack - Bottle shelf with fixed trap - MultiBox for butter and cheese - CrispZone drawer featuring HumidityControl - FreshZone drawer
Equipment of freezer	<ul style="list-style-type: none"> - 1 XXL SpaceBox drawer - 2 drawers for freezing - 2 glass shelves
Technical data	<ul style="list-style-type: none"> - Energy consumption kWh/24h: 0.643 kWh - Level of noise (max.): 42 dB(A)re 1 pW - Product dimensions (HxWxD): 185 × 60 × 64 cm - EAN code: 3838942111471 - Product code: 547223



NRK 6192 MRDUK
- Colour: Fiery Red
- EAN code: 3838942111464
- Product code: 547214



NRK 6192 MCUK
- Colour: Champagne
- EAN code: 3838942111440
- Product code: 547174



RK 6192 ECUK

Freestanding fridge freezer

Colour Edition

A⁺⁺ Energy Class



- Colour: Champagne
- Reversible door opening
- Door material: Steel sheet
- Climate class: SN, ST, N, T

Efficiency	<ul style="list-style-type: none"> - 1 compressor - Total gross/net volume: 326 / 324 l - Capacity of cooling compartment: gross/net: 229 / 229 l - Capacity of freezer compartment: gross/net: 97 / 95 l - Freezing capacity in 24 hours: 4.5 kg / 24h - Power cut safe time: 30 h
Control	<ul style="list-style-type: none"> - Mechanical control
Features	<ul style="list-style-type: none"> - Slot-in: possibility to put the appliance into the kitchen niche 60 cm - FrostLess: Less ice building in the freezer
Equipment of refrigerator	<ul style="list-style-type: none"> - Egg/Ice bin: 1 x 7 - SimpleSLide height adjustable door shelves: 2 - Type of interior light: LED strip on the ceiling - 4 glass shelves - Bottle rack - Bottle shelf with fixed trap - CrispZone drawer featuring HumidityControl - FreshZone drawer
Equipment of freezer	<ul style="list-style-type: none"> - 1 XXL SpaceBox drawer for freezing - 2 drawers for freezing - 2 glass shelves
Technical data	<ul style="list-style-type: none"> - Energy consumption kWh/24h: 0.635 kWh - Energy consumption kWh/year: 232 kWh - Level of noise (max.): 40 dB(A)re 1 pW - Product dimensions (HxWxD): 185 × 60 × 64 cm - EAN code: 3838942257377 - Product code: 453688



RK 6192 EOUK

- Colour: Juicy Orange
- EAN code: 3838942259081
- Product code: 453721



RK 6192 ERDUK

- Colour: Fiery Red
- EAN code: 3838942258077
- Product code: 453689



RK 6192 EBKUK

- Colour: Black
- EAN code: 3838942259098
- Product code: 453722

**R 6192 FWUK**

- Colour: White
- EAN code: 3838942001536
- Product code: 469372

FN 6192 CWUK

- Colour: White
- EAN code: 3838942000911
- Product code: 469330

R 6192 FXUK
 Freestanding refrigerator

Essential Line

FN 6192 CXUK
 Freestanding NoFrost freezer

Essential Line

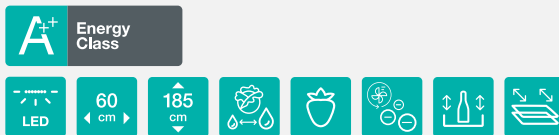

- Colour: Stainless steel
- Reversible door opening
- Door material: Genuine Inox with TouchFree coating
- Climate class: SN, ST, N, T



- Colour: Stainless steel
- Reversible door opening
- Door material: Genuine Inox with TouchFree coating
- Climate class: SN, ST, N, T

Efficiency	<ul style="list-style-type: none"> - 1 compressor - Total gross/net volume: 370 / 368 l - Capacity of cooling compartment: gross/net: 370 / 368 l 	<ul style="list-style-type: none"> - 1 compressor - Total gross/net volume: 277 / 243 l - FastFreeze - Freezing capacity in 24 hours: 18 kg - Power cut safe time: 15 h
Control	- Mechanical control	- Electronic control behind the door
Features	<ul style="list-style-type: none"> - Slot-in: possibility to put the appliance into the kitchen niche 60 cm - IonAir with DynamiCooling 	<ul style="list-style-type: none"> - Slot-in: possibility to put the appliance into the kitchen niche 60 cm - Automatic defrost freezer - NoFrost
Equipment of refrigerator	<ul style="list-style-type: none"> - Egg/Ice bin: Egg/Ice bin: 1 x 7 - SimpleSLide height adjustable door shelves: 3 - Type of interior light: LED - 7 glass shelves - Bottle rack - Bottle shelf without trap - Bottle shelf with fixed trap - CrispZone drawer featuring HumidityControl - CrispZone vegetable drawer - FreshZone drawer 	
Equipment of freezer		<ul style="list-style-type: none"> - Illuminated interior of freezer compartment: LED light - Freezing compartment: 1 door, 6 drawers - 6 glass shelves
Technical data	<ul style="list-style-type: none"> - Energy consumption kWh/24h: 0.312 kWh - Energy consumption kWh/year: 114 kWh - Level of noise (max.): 38 dB(A)re 1 pW - Product dimensions (HxWxD): 185 x 60 x 64 cm - EAN code: 3838942001543 - Product code: 469373 	<ul style="list-style-type: none"> - Energy consumption kWh/24h: 0.649 kWh - Energy consumption kWh/year: 237 kWh - Level of noise (max.): 42 dB(A)re 1 pW - Product dimensions (HxWxD): 185 x 60 x 64 cm - EAN code: 3838942001529 - Product code: 469371

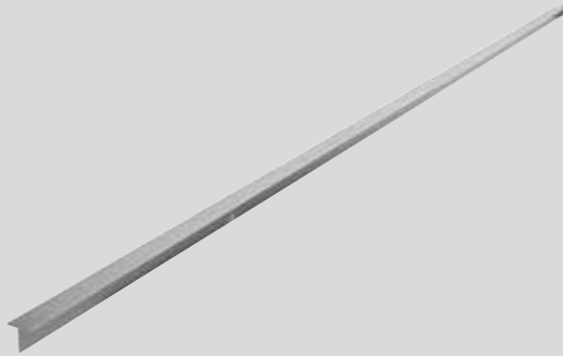

CFS-AR029

Linking kit

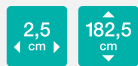

Technical data

- Product dimensions (HxWxD): 182.5 × 2.5 × 2.5 cm
- EAN code: 3838942587399
- Product code: 461944



FN 6192 CXUK & Linking kit & R 6192 FXUK



FN 6192 CWUK & Linking kit & R 6192 FWUK





A WASHER WITH A GENTLE HEART

Washing machines

Gorenje washing machines are a reliable partner in the daily care of your laundry. It understands the limited amount of time and patience for every day mundane tasks. Therefore, it offers programmes that are a perfect fit of different lifestyles and offer every user the functions they desire. It can wash quickly; it can wash environmentally friendly. It can be silent; they can be meticulously thorough. Regardless of the mode you choose, your laundry will always be washed gently and with care. The fabric will remain fresh and flexible, and the colours will retain the right hue.

SensoCare

Perfection in washing

SensoCare technology makes sure every type of fabric is washed in the best possible way. It always delivers the optimum combination of temperature and amount of water, time, and spin speed. If, however, your clothes need a very special care, the cotton and synthetic fibre programmes can be tweaked with

extra modes and functions. NormalCare selects the optimum combination of all four parameters for each load of laundry; TimeCare reduces the washing time; AllergyCare uses more water and extra rinse cycles; and EcoCare is the most energy-efficient washing mode.



TimeCare

40% quicker wash

Intensive and quicker wash for less soiled laundry and smaller loads.



EcoCare

60% energy savings

The wash is somewhat longer, but it uses less water and power.



AllergyCare

Efficient rinse

Additional level of water and thorough rinse are more efficient in removing the traces of detergent and thereby the allergens that could cause an unpleasant sensation on the skin.

SpaDrum

Total laundry care

The SensoCare washing machine drum is made from the best quality stainless steel with exceptionally smooth surface. Therefore, the laundry is thoroughly washed, rinsed, and spun without any damage.



Perforation

Water gently spraying into the drum

Small holes with a diameter of no more than 3 millimetres treat your laundry especially gently. In addition to effective washing, spinning, and rinsing, they also prevent any damage to your laundry. Moreover, the size, shape and pattern of drum perforation reduce the consumption of power and water.



3D ribs

Gentle waving of the laundry

First, the wavy ribs gently push the laundry towards the rear end of the drum; then, they lift it toward to top. This improves the distribution of laundry within the drum, and delicately massages the fabric. Additional water is sprayed from the openings in the rib surface for better soaking.



Tilted 4D door

Always on the right path

Improved patented glass washing machine door is designed for active 4D motion of the laundry towards the central part of the drum where it receives the best treatment and maximum protection. Laundry is better washed and less wrinkled, appliance quieter with extended lifetime.



UltraWhite

White that will never turn grey

Synthetic fibres, silk, and nylon are easily damaged in machine washing. Therefore, a special programme has been developed to wash at lower temperatures and preserve the quality of your delicates. Gentle tumbling with a larger amount of water delivers perfect whiteness at no more than 30 °C. Use of specialized detergents is recommended for extra freshness.



PerfectBlack

There is only one black

A special washing programme for all types of black fabric is highly efficient with gentle tumbling at no more than 30 °C. This does away with the need for intensive tumbling and use of aggressive detergents that make the laundry fade to grey. Specialized detergents are recommended for delicate black laundry.



Anti-allergy programmes

For extra protection of delicate skin of babies and adults

Anti-allergy Cotton, Baby, Anti-Mites programmes use higher temperature, more water, and extra rinsing. As a result, the detergent is dissolved more efficiently and the laundry is very thoroughly rinsed. Washing powder, allergens, and mites that could cause an unpleasant sensation on sensitive or particularly delicate baby skin will be eliminated from your clothing, bedding, and larger clothing items.



NightWash

The laundry can also be easily and silently washed at night. The drum spins more slowly and gently, but this is compensated with a somewhat longer wash that leaves the laundry perfectly clean.



BioWash

A perfect solution for all who use organic washing agents such as laundry balls or soap nuts. The combination of a larger amount of water, temperatures of up to 90 °C, and fast tumbling allows optimum use of the organic washing agents and clean laundry.



MyFavourite

Your washing machine can simply memorize your favourite or most frequently used programmes to make them always available for instant selection. It can also memorize all extra settings such as adjusted washing temperature, spinning speed, or a pre-wash.



SportWash

Gentle tumbling of the laundry in a large amount of water at 30 to 40 °C is ideal for washing synthetic fibres. Thus, your sportswear will always be fresh and pleasantly smelling, ready for new endeavours.



HandWash + Wool

This programme takes care of woollen, silk, or lace garments as if they were washed by a pair of caring hands. The shape and quality will be maintained, and the stains and dirt will be removed at temperatures as low as 30 to 40 °C.



QuickWash 17'

Less soiled laundry can be easily refreshed in 17 minutes at a temperature of 30 °C. Thus, your next outfit will always be ready.

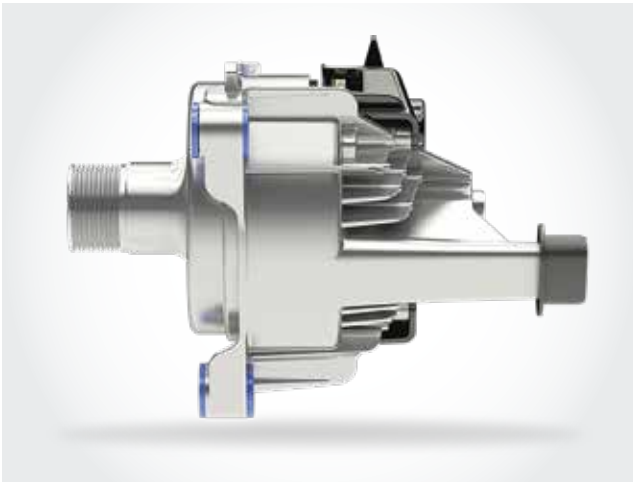

InverterPowerDrive

Remarkable power, high efficiency

The powerful motor is brushless, which eliminates and mechanical tension, friction, or wear. The results are better, power savings are higher, and the washing process is notably quieter. Moreover, appliance useful life is longer, too.



TotalWeightControl

Superior washing results regardless of the amount of laundry

The sensor adjusts all washing parameters to the amount of laundry in the drum. This leads to optimum use of water and power, shorter wash, and considerably quieter operation. A full basket of laundry, no matter how large, will be clean and pleasantly smelling.



StainExpert

Expert in stains

Effective removal of stains no longer requires high temperature or additional treatment of clothing before the wash. The perfect combination of temperature, time, and water will automatically remove four types of stubborn stains: fruit (oranges, tomato sauce); organic stains (fat, butter, eggs, grass); wine (dark fruit juices, ink); and coffee (tea, yoghurt, pasta, make-up). The StainExpert function is available in the Superior washing machines.



DuraHeat

Safe and durable

The redesigned and improved heater includes an overheating protection system. This extends its useful life and makes washing machine operation safer.

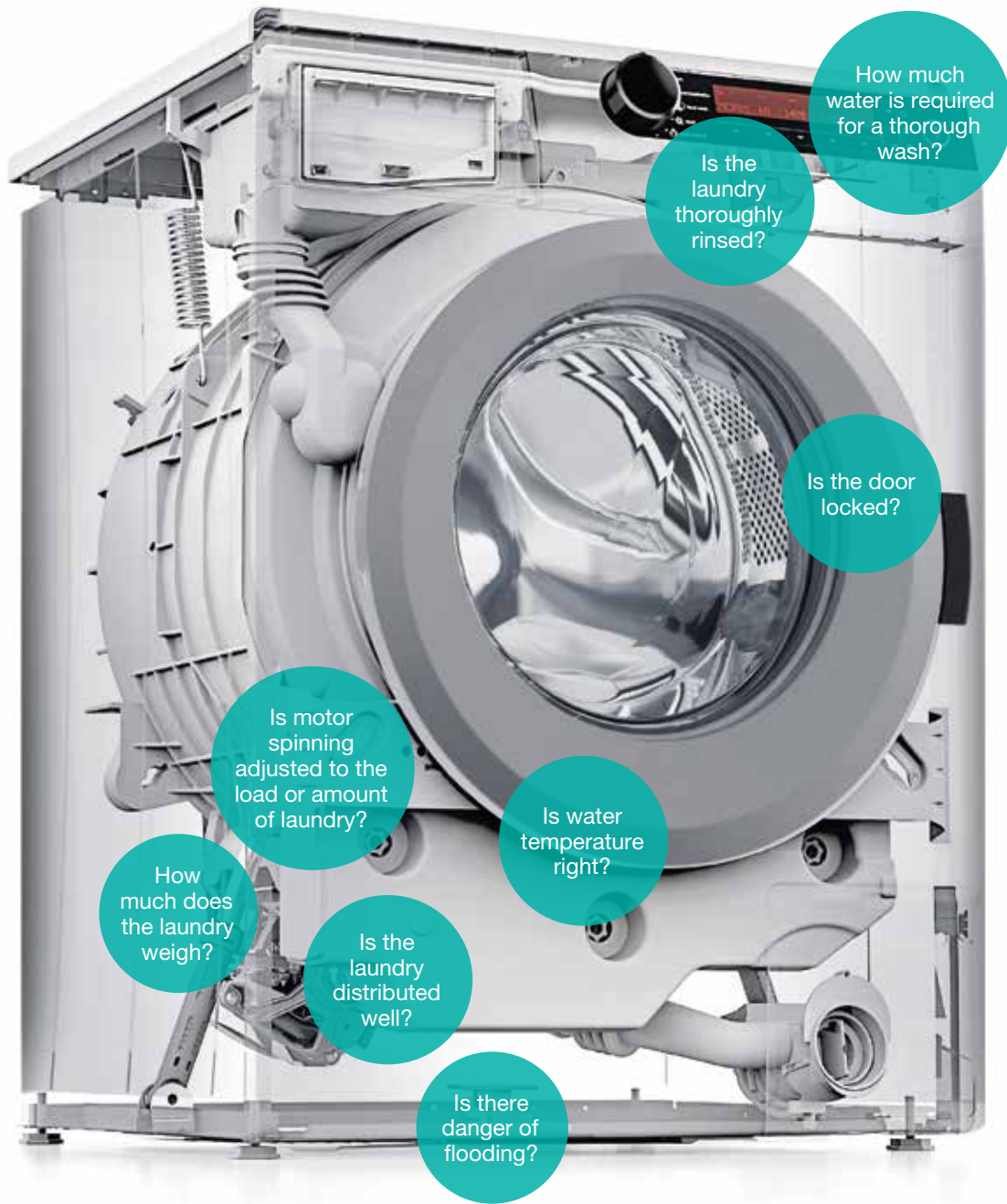

Sensor IQ

Smart wash

The sensor system controls washing process and makes sure it is perfect. Smart technology adjusts the amount of water and washing time to the selected program, and type and weight of the laundry. The results is excellently washed laundry and lower use of power, water, and time.

Friendly design

Gorenje washing machines are designed to be functional and ergonomic, which makes their use inspiringly simple. The control panel is tilted by 20° and the door opening has a large 34 cm diameter for easier filling and emptying of the washing machine. Filters and detergent dispenser are also easy to clean.

SteriTub

This program makes sure the washing machine interior stays perfectly clean and sterile, allowing a pleasant smell of the laundry. Washing with washing powder at lower temperatures may lead to ideal conditions for development of bacteria which in turn could cause a foul smell of your laundry. The SteriTub works with the drum empty and eliminates and bacteria from the machine interior.

A+++ -20%

All washing machines are highly energy-efficient. Those ranking in the A+++ -20% energy class use 50% less power than the A-class appliances.

ChildLock

During the wash, the door stays locked, preventing even the most inquisitive child from opening it. For added protection, the control panel can be locked by pressing a special combination of keys, making it impossible to inadvertently change the settings.

AquaStop

The safety system automatically shuts off the water supply to the hose and the machine in case of a leak to prevent flooding. The pump automatically pumps out the remaining water from the drum into the discharge hose. Thus, the washing machine can be left to operate unsupervised, without any fear of flooding. High-end models feature a special sensor installed at the bottom of the washing machine. In case of a leak, the sensor will immediately cut off the supply of water into the appliance.

Zn Zinc-coated housing

Gorenje washing machines are coated with an environmentally friendly protective layer that fends off rust and extends the useful life of the appliance.

SuperSilent

Quality drive and insulation allows the SensoCare washing machines to operate quietly. Even during the hardest spin, it will not be louder than a normal conversation. Top models excel with extra silent operation.



SUPERIOR line



ESSENTIAL line

		Standard 60 cm
CAPACITY	6kg	
	7kg	
	8kg	
	9kg	●
SPIN SPEED	600	
	800	
	1000	
	1200	
	1400	
	1600	●
ENERGY CLASS	A++	
	A+++	
	A+++ -10%	
	A+++ -20%	●
DISPLAY	LED diodes	
	LED	
	LCD	
	Large LCD	●
4 WASHING MODES	(NormalCare, EcoCare, AllergyCare, TimeCare)	●
SPECIAL PROGRAMMES	UltraWhite	●
	PerfectBlack	●
	Anti-allergy programmes	
	MyFavorite	●
	BioWash	●
	NightWash	●
	StainExpert	●
NO. OF SENSORS	6	
	7	
	8	●
SOAKING SYSTEM	Showering	
	Showering+ Jet (QuickWet)	●
DRUM CAPACITY	42l	
	54l	
	64l	●
TUB	Carbotech	
	Fibertech	●
MOTOR	Standard collector motor	
	InverterPowerDrive	●
SAFETY	AquaStop	
	Total AquaStop	●

		Slim 45 cm	Standard 60 cm
CAPACITY	6kg	●	
	7kg		●
	8kg		●
	9kg		●
SPIN SPEED	600		
	800		
	1000		
	1200	●	
	1400		●
	1600		●
ENERGY CLASS	A++		
	A+++	●	●
	A+++ -10%		●
	A+++ -20%		●
DISPLAY	LED diodes		
	LED	●	●
	LCD		
	Large LCD		
4 WASHING MODES	(NormalCare, EcoCare, AllergyCare, TimeCare)	●	●
SPECIAL PROGRAMMES	UltraWhite	●	●
	PerfectBlack	●	●
	Anti-allergy programmes		
	MyFavorite	●	●
	BioWash	●	●
	NightWash	●	●
	StainExpert		
NO. OF SENSORS	6		
	7	●	●
	8		
SOAKING SYSTEM	Showering	●	●
	Showering+ Jet (QuickWet)		●
DRUM CAPACITY	42l	●	
	54l		●
	64l		●
TUB	Carbotech	●	●
	Fibertech		●
MOTOR	Standard collector motor	●	●
	InverterPowerDrive		●
SAFETY	AquaStop		●
	Total AquaStop		



COLOUR edition

		Standard 60 cm
CAPACITY	6kg	
	7kg	
	8kg	●
	9kg	
SPIN SPEED	600	
	800	
	1000	
	1200	
	1400	●
	1600	
ENERGY CLASS	A++	
	A+++	●
	A+++ -10%	
	A+++ -20%	
DISPLAY	LED diodes	
	LED	●
	LCD	
	Large LCD	
4 WASHING MODES	(NormalCare, EcoCare, AllergyCare, TimeCare)	●
SPECIAL PROGRAMMES	UltraWhite	●
	PerfectBlack	●
	Anti-allergy programmes	●
	MyFavorite	●
	BioWash	●
	NightWash	●
	StainExpert	
NO. OF SENSORS	6	
	7	●
	8	
SOAKING SYSTEM	Showering	●
	Showering+ Jet (QuickWet)	
DRUM CAPACITY	42l	
	54l	
	64l	●
TUB	Carbotech	
	Fibertech	●
MOTOR	Standard collector motor	●
	InverterPowerDrive	
SAFETY	AquaStop	●
	Total AquaStop	



W 98F65 E/IUK
Washing machine

Superior Line



- Colour: White



W 95F64 P/IUK
Washing machine

Essential Line



- Colour: White

Efficiency	<ul style="list-style-type: none"> - Inverter PowerDrive - SensoCARE - StainExpert - Special drum construction SpaDrum - Spin speed: 1600 rpm - Washer load: 1-9 kg - Drum volume: 64 l - Drum illumination with LED light 	<ul style="list-style-type: none"> - Inverter PowerDrive - SensoCARE - Special drum construction SpaDrum - Spin speed: 1600 rpm - Washer load: 1-9 kg - Drum volume: 64 l
Control	<ul style="list-style-type: none"> - Type of display: LCD - TimeComfort - Presetting time delay of start - Preset washing EndTime / Adjustable spin speed / Temperature setting / Cold wash: Button / Personal settings for all programmes 	<ul style="list-style-type: none"> - Type of display: LED - Presetting time delay of start - Adjustable spin speed - Temperature setting / Cold wash: Button / Personal settings for all programmes
Programmes	<ul style="list-style-type: none"> - 31 programmes - Cotton, Wool, QuickWash, Mix/synthetics - programme for synthetics and fabrics of mixed materials, HandWash - Special programmes: BioWash, MyFavorite, NightWash, UltraWhite, PerfectBlack, SportWash, Quick wash 17', Cotton 20°C - Prewash selection 	<ul style="list-style-type: none"> - 23 programmes - Cotton, Wool, QuickWash, Mix/synthetics - programme for synthetics and fabrics of mixed materials, HandWash - Special programmes: BioWash, MyFavorite, NightWash, UltraWhite, PerfectBlack, SportWash, Quick wash 17', Cotton 20°C - Prewash selection
Features	<ul style="list-style-type: none"> - StableTech side panels - Audio signal SoftSound - Self cleaning program SteriTub - Pump STOP - Cold & hot water connection 	<ul style="list-style-type: none"> - StableTech side panels - Audio signal SoftSound - Self cleaning program SteriTub - Pump STOP - Cold water connection
SensorIQ technology	<ul style="list-style-type: none"> - Automatic recognition of laundry weight TotalWeight - Water level sensor / QuickWet / ECOSystem 	<ul style="list-style-type: none"> - Automatic recognition of laundry weight TotalWeight - Water level sensor / QuickWet / ECOSystem
Safety and durability	<ul style="list-style-type: none"> - Durable heater DuraHeat - Total Aqua STOP - Overflow protection - Child protection (CDP) / Stability Control (SCS) - FiberTech 	<ul style="list-style-type: none"> - Durable heater DuraHeat - Partial AquaStop - Overflow protection - Child protection (CDP) / Stability Control (SCS) - FiberTech
Technical data	<ul style="list-style-type: none"> - Energy consumption kWh/year: 170 kWh - Annual water consumption: 10654 l - Level of noise (max.): 74 dB(A)re 1 pW - Product dimensions (HxWxD): 85 x 60 x 60 cm - EAN code 3838942081286 - Product code: 517217 	<ul style="list-style-type: none"> - Energy consumption kWh/year: 187 kWh - Annual water consumption: 10780 l - Level of noise (max.): 76 dB(A)re 1 pW - Product dimensions (HxWxD): 85 x 60 x 60 cm - EAN code: 3838942081262 - Product code: 517216

5
YEAR
WARRANTY

W 8543 C
Washing machine

Essential Line

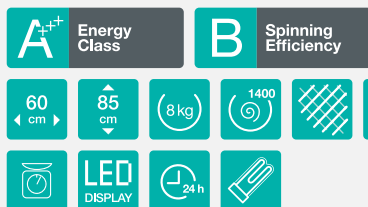

- Colour: White

5
YEAR
WARRANTY

W 7543 LC
Washing machine

Essential Line

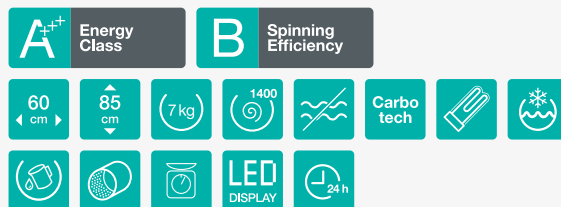

- Colour: White

Efficiency

- Standard collector motor
- SensoCARE
- Special drum construction SpaDrum
- Spin speed: 1400 rpm
- Washer load: 1-8 kg
- Drum volume: 64 l

- Standard collector motor
- SensoCARE
- Special drum construction SpaDrum
- Spin speed: 1400 rpm
- Washer load: 1-7 kg
- Drum volume: 54 l

Control

- Type of display: LED
- Presetting time delay of start
- Adjustable spin speed
- Temperature setting
- Cold wash: Button / Personal settings for all programmes

- Type of display: LED
- Presetting time delay of start
- Adjustable spin speed
- Temperature setting
- Cold wash: Button / Personal settings for all programmes

Programmes

- 23 programmes
- Cotton, Wool, QuickWash, Mix/synthetics - programme for synthetics and fabrics of mixed materials, HandWash
- Special programmes: BioWash, MyFavorite, NightWash, UltraWhite, PerfectBlack, SportWash, Quick wash 17', Cotton 20°C

- 23 programmes
- Cotton, Wool, QuickWash, Mix/synthetics - programme for synthetics and fabrics of mixed materials, HandWash
- Special programmes: BioWash, MyFavorite, NightWash, UltraWhite, PerfectBlack, SportWash, Quick wash 17', Cotton 20°C

Features

- StableTech side panels
- Audio signal SoftSound
- Self cleaning program SteriTub
- Pump STOP
- Cold water connection

- StableTech side panels
- Audio signal SoftSound
- Self cleaning program SteriTub
- Pump STOP
- Cold water connection

SensorIQ technology

- Automatic recognition of laundry weight TotalWeight
- Water level sensor / ECOSystem

- Automatic recognition of laundry weight TotalWeight
- Water level sensor / ECOSystem

Safety and durability

- Durable heater DuraHeat
- Overflow protection
- Child protection (CDP)
- Stability Control (SCS)
- FiberTech

- Durable heater DuraHeat
- Partial AquaStop
- Overflow protection
- Child protection (CDP) / Stability Control (SCS)
- Carbotech tub

Technical data

- Energy consumption kWh/year: 192 kWh
- Annual water consumption: 10340 l
- Level of noise (max.): 74 dB(A)re 1 pW
- Product dimensions (HxWxD): 85 × 60 × 60 cm
- EAN code: 3838942269059
- Product code: 454594

- Energy consumption kWh/year: 166 kWh
- Annual water consumption: 9586 l
- Level of noise (max.): 73 dB(A)re 1 pW
- Product dimensions (HxWxD): 85 × 60 × 60 cm
- EAN code: 3838942919879
- Product code: 417994



W 6523/SC Washing machine

Essential Line



- Colour: White

Efficiency	<ul style="list-style-type: none"> - Standard collector motor - SensoCARE - Special drum construction SpaDrum - Spin speed: 1200 rpm - Washer load: 1-6 kg - Drum volume: 42 l
Control	<ul style="list-style-type: none"> - Type of display: LED - Presetting time delay of start - Adjustable spin speed - Temperature setting - Cold wash: Button - Personal settings for all programmes
Programmes	<ul style="list-style-type: none"> - 23 programmes - Cotton, Wool, QuickWash, Mix/synthetics - programme for synthetics and fabrics of mixed materials, HandWash - Special programmes: BioWash, MyFavorite, NightWash, UltraWhite, PerfectBlack, SportWash, Quick wash 17', Cotton 20°C
Features	<ul style="list-style-type: none"> - StableTech side panels - Audio signal SoftSound - Self cleaning program SterilTub - Pump STOP - Cold water connection - Slim Depth
SensorIQ technology	<ul style="list-style-type: none"> - Automatic recognition of laundry weight TotalWeight - Water level sensor - ECOSystem
Safety and durability	<ul style="list-style-type: none"> - Durable heater DuraHeat - Overflow protection - Child protection (CDP) / Stability Control (SCS) - Carbotech tub
Technical data	<ul style="list-style-type: none"> - Energy consumption kWh/year: 153 kWh - Annual water consumption: 9209 l - Level of noise (max.): 70 dB(A)re 1 pW - Product dimensions (HxWxD): 85 × 60 × 44 cm - EAN code: 3838942948749 - Product code: 432150



W 8543 LB Colour Edition
Washing machine

A⁺⁺ Energy Class	B Spinning Efficiency
60 cm	85 cm
8 kg	1400 rpm
IQ	LED DISPLAY
24h	

- Colour: Black

Efficiency	<ul style="list-style-type: none"> - Standard collector motor - SensoCARE - Special drum construction SpaDrum - Spin speed: 1400 rpm - Washer load: 1-8 kg - Drum volume: 64 l
Control	<ul style="list-style-type: none"> - Type of display: LED - Presetting time delay of start - Adjustable spin speed - Temperature setting - Cold wash: Button - Personal settings for all programmes
Programmes	<ul style="list-style-type: none"> - 23 programmes - Cotton, Wool, QuickWash, Mix/synthetics - programme for synthetics and fabrics of mixed materials, HandWash - Special programmes Allergy programme - effective removal of dirt, micro organisms and detergent residues, Baby clothes, Anti mites, PerfectBlack, Active, SilentWash, Quick wash 17', Cotton 20°C - Ability to create own programmes: MyFavorite - Prewash selection
Features	<ul style="list-style-type: none"> - StableTech side panels - Audio signal SoftSound - Self cleaning program SterilTub - Pump STOP - Cold water connection
SensorIQ technology	<ul style="list-style-type: none"> - Automatic recognition of laundry weight TotalWeight - Water level sensor / ECOSystem
Safety and durability	<ul style="list-style-type: none"> - Durable heater DuraHeat - Partial Aqua Stop / Overflow protection - Child protection (CDP) / Stability Control (SCS) - FiberTech
Technical data	<ul style="list-style-type: none"> - Energy consumption kWh/year: 192 kWh - Annual water consumption: 10340 l - Level of noise (max.): 73 dB(A)re 1 pW - Product dimensions (HxWxD): 85 × 60 × 60 cm - EAN code: 3838942608292 - Product code: 460779



W 8543 LA
- Colour: Silver
- EAN code: 3838942608742
- Product code: 460778



W 8543 LR
- Colour: Fiery Red
- EAN code: 3838942609282
- Product code: 460776



W 8543 LO
- Colour: Juicy Orange
- EAN code: 3838942606847
- Product code: 460780





ALWAYS NICELY DRY

Tumble dryers

A Gorenje laundry dryer can easily become your best friend, especially when you are in a hurry. Its drum delivers the power of negative ions that make the laundry extra soft, pleasantly smelling, and free of allergens. It also dries the laundry in a way that makes ironing very easy and often not required at all. In a Gorenje dryer, the fabric keeps its shape, flexibility, and stiffness. Dryer interior is large enough for large amounts of laundry. Models fitted with a heat pump, are also excitingly economical in terms of power consumption.

SensoCare

Sensationally soft laundry

The SensoCare technology makes sure that each type of fabric is dried in the best possible way. The combination of temperature, steam, drying time, and drum rotation afford drying

conditions tailored to your laundry. While NormalCare delivers improved drying programs for all types of laundry, GentleCare will provide a friendlier care for your delicates.



IonTech

Fighting the allergies with ions

In SensoCare dryers, air full of negatively charged ions dries the laundry in a way that considerably reduces creasing of your clothes. The ionizer emits negative ions to effectively eliminate most allergens, residues of smoke and pollen, and the electrostatic charge accumulated during the drying process. As a result, the clothes have a better smell and they are easier to iron.



SteamTech

Fewer creases, less ironing

Additional steam treatment at the end of the selected program will make sure your clothes are much smoother. The drum is filled with steam that penetrates every fibre for softer laundry that hardly requires any ironing.



GentleCare

Gentle drying of delicate fabrics

Specialized care of the most delicate fabrics operates at a low temperature of 40 °C. A longer drying cycle is entirely safe and reliable as it protects your clothes from any deforming or damage.



HeatPump with TwinAir Revolutionary drying efficiency

All heat pump dryers boast high energy efficiency. High end models rank in the A+++ energy class, saving 63% of energy compared to those in the A energy class. Gorenje A+++ class dryer with a capacity of 9 kg is unique in the market. Optimized heat pump in one of the largest drums in the world, with a

capacity of 120 litres, can easily deal with major amounts of laundry. This is also made possible by the broader air channels. It also dries more gently than conventional drying systems. The temperature in the dryer is at the ideal 50 °C to prevent from overdrying.



TwinAir Evenly dried for simple ironing

Soft, evenly dried, less creased laundry that is easy to iron, straight from the dryer. This is made possible by the bi-directional air blowing system which adjusts the air blowing direction to the direction of drum rotation using a special flap on the fan.



Sensor IQ

Sensor technology for safe operation

Smart sensor technology automatically controls the drying process according to the selected program, type of laundry, and desired dryness of laundry. Efficient sensor communication prevents any errors

and maintains the best possible laundry drying environment. The sensors also monitor all other parameters to reduce power consumption.



FiltrationSupreme

Gorenje has the most efficient filtering system in the world, providing 40% more efficient air filtering than conventional systems. It includes a special 3D filter installed before the condenser unit, a filter on the dryer door, and a filter in the drum. These filters catch even the tiniest bits of dust and lint from the clothes. After the drying cycle, the latter two filters are simply wiped.



User-friendly condensate tank

The dryers condense all the moisture and drain it into a special tank. This does away with any worries regarding air evacuation. The light on the tank signals when the tank is full. The tank can be easily removed and emptied, and the water can be used elsewhere in your household.



AutoDrain

Condensation dryer with the AutoDrain drain hose can be connected to your drain system to do away with the need for manual emptying of the condensate tank.



Friendly design

Gorenje dryers have a clearly laid out control panel that is slightly tilted to allow a clearer view. They are designed for simple and pleasant use, featuring one of the largest door openings, simple opening system, and easily accessible filters and condensate tank.



Top energy efficiency

A+++ is one of the best energy ratings you can get for a tumble dryer. Upgrading to a A+++ tumble dryer could save you £28 every year when compared to a C-rated model of the same size, that's enough money saved to pay for your daily newspaper for 40 days!

(This is for the Gorenje D98F66EUK. Figures based on the EU Energy Label energy consumption. This assumes 160 loads per year. Average electricity price of 13.86p/kWh. Lifetime assumed to be 13 years - source: DEFRA/DECC Powering the Nation 2. Assumed retail cost of £659. Correct as of January 2016).





SUPERIOR line



ESSENTIAL line

CAPACITY	6 kg	
	7 kg	
	8 kg	
	9 kg	●
ENERGY CLASS	C	
	B	
	A+	
	A++	●
	A+++	
DISPLAY	LED diodes	
	LED	
	LCD	●
OPERATION	Vents	
	Condenser	
	Condenser with HeatPump	●
CONTROL	Sensors	●
NO. OF PROGRAMS	15	
	27	●
DRUM CAPACITY	117 l	
	120 l	●
DRYING MODES	NormalCare	●
	GentleCare	●
DRUM	Drum illumination	●
	IonTech	●
	SteamTech	●
	TwinAir	●

CAPACITY	6 kg	
	7 kg	●
	8 kg	
	9 kg	●
ENERGY CLASS	C	
	B	●
	A+	
	A++	●
	A+++	
DISPLAY	LED diodes	
	LED	●
	LCD	
OPERATION	Vents	
	Condenser	●
	Condenser with HeatPump	●
CONTROL	Sensors	●
NO. OF PROGRAMS	15	●
	27	
DRUM CAPACITY	117 l	●
	120 l	●
DRYING MODES	NormalCare	●
	GentleCare	
DRUM	Drum illumination	●
	IonTech	●
	SteamTech	
	TwinAir	●



COLOUR edition

CAPACITY	6 kg	
	7 kg	
	8 kg	●
	9 kg	
ENERGY CLASS	C	
	B	
	A+	
	A++	●
	A+++	
DISPLAY	LED diodes	
	LED	●
	LCD	
OPERATION	Vents	
	Condenser	
	Condenser with HeatPump	●
CONTROL	Sensors	●
NO. OF PROGRAMS	15	●
	27	
DRUM CAPACITY	117 l	
	120 l	●
DRYING MODES	NormalCare	●
	GentleCare	
DRUM	Drum illumination	●
	IonTech	●
	SteamTech	
	TwinAir	●



D 98F65 EUK Superior Line
Freestanding condenser tumble dryer

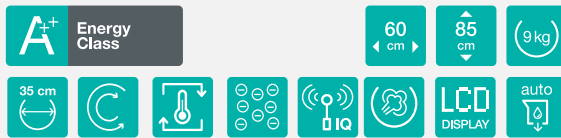

- Colour: White



D 95F65 NUK Essential Line
Freestanding condenser tumble dryer

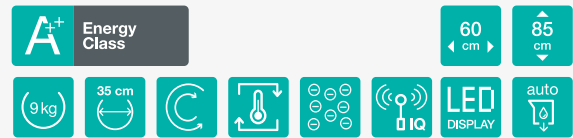

- Colour: White

Efficiency	<ul style="list-style-type: none"> - Single phase asynchronous motor - Dryer load: Large drum volume - 9 kg - IonTech technology - TwinAir - Heat pump - Drum volume: 120 l - Drum illumination with LED light - Porthole diameter: 35 cm - Door opening angle: 180 ° - Reversible drum action 	<ul style="list-style-type: none"> - Single phase asynchronous motor - Dryer load: Large drum volume - 9 kg - IonTech technology - TwinAir - Heat pump - Drum volume: 120 l - Drum illumination with LED light - Porthole diameter: 35 cm / Door opening angle: 180 ° - Reversible drum action - Direct discharge of condensate AutoDrain
Control	<ul style="list-style-type: none"> - Personal settings for all programmes - Type of display: LCD - Presetting time delay of start 	<ul style="list-style-type: none"> - Personal settings for all programmes - Type of display: LED - Presetting time delay of start
Programmes	<ul style="list-style-type: none"> - 27 programmes - Programmes: Bedding - programme for bedding and other large items, Wool, Shirts programme - lower temperature and slight remaining moisture to reduce wrinkles, Steam refresh, Mix dry, Mix iron dry - SteamTech - Drying time selection: Step setting 	<ul style="list-style-type: none"> - 15 programmes - Programmes: Bedding - programme for bedding and other large items, Wool, Shirts programme - lower temperature and slight remaining moisture to reduce wrinkles, Steam refresh, Mix dry, Mix iron dry - Drying time selection: Step setting
Functions	<ul style="list-style-type: none"> - Lower temperature of drying - Anticrease system 	<ul style="list-style-type: none"> - Refresh - Anticrease system
Features	<ul style="list-style-type: none"> - Audio signal SoftSound - FiltrationSupreme - Drying phase indicator - Signal for "full water container" - Remaining time on display - Vacuum feet 	<ul style="list-style-type: none"> - Audio signal SoftSound - FiltrationSupreme - Drying phase indicator - Signal for "full water container" - Remaining time on display - Vacuum feet
SensorIQ technology	<ul style="list-style-type: none"> - Humidity sensor - Service diagnostic indicator 	<ul style="list-style-type: none"> - Humidity sensor - Service diagnostic indicator
Safety and durability	<ul style="list-style-type: none"> - Protective thermostat - Automatic switch off when door is open - Child protection (CDP) - Stainless steel inner/outer drum 	<ul style="list-style-type: none"> - Protective thermostat - Automatic switch off when door is open - Child protection (CDP) - Stainless steel inner/outer drum
Technical data	<ul style="list-style-type: none"> - Noise level: 66 dB(A)re 1 pW - Energy consumption kWh/year: 259 kWh - Product dimensions (HxWxD): 85 × 60 × 60 cm - EAN code: 3838942079207 - Product code: 517213 	<ul style="list-style-type: none"> - Noise level: 65 dB(A)re 1 pW - Energy consumption kWh/year: 259 kWh - Product dimensions (HxWxD): 85 × 60 × 60 cm - EAN code: 3838942079214 - Product code: 517214



D 744 BJ Essential Line

Freestanding condenser tumble dryer

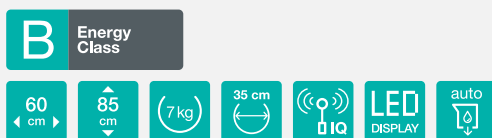

- Colour: White

Efficiency	<ul style="list-style-type: none"> - Single phase asynchronous motor - Dryer load: 1-7 kg - Energy-saving electric heater - Drum volume: 117 l - Drum illumination with LED light - Porthole diameter: 35 cm - Door opening angle: 180 ° - Reversible drum action - Direct discharge of condensate AutoDrain
Control	<ul style="list-style-type: none"> - Personal settings for all programmes - Type of display: LED - Presetting time delay of start
Programmes	<ul style="list-style-type: none"> - 15 programmes - Programmes: Bedding - programme for bedding and other large items, Wool, Shirts programme - lower temperature and slight remaining moisture to reduce wrinkles, Steam refresh, Mix dry, Mix iron dry - Drying time selection: Step setting
Functions	<ul style="list-style-type: none"> - Lower temperature of drying - Antcrease system
Features	<ul style="list-style-type: none"> - Audio signal SoftSound - FiltrationSupreme - Drying phase indicator - Signal for "full water container" - Remaining time on display - Vacuum feet
SensorIQ technology	<ul style="list-style-type: none"> - Humidity sensor - Service diagnostic indicator
Safety and durability	<ul style="list-style-type: none"> - Protective thermostat - Automatic switch off when door is open - Child protection (CDP) - Stainless steel inner/outer drum
Technical data	<ul style="list-style-type: none"> - Noise level: 65 dB(A)re 1 pW - Energy consumption kWh/year: 504 kWh - Product dimensions (HxWxD): 85 × 60 × 60 cm - EAN code: 3838942914676 - Product code: 415087



D 8565 NO Colour Edition

Freestanding condenser tumble dryer

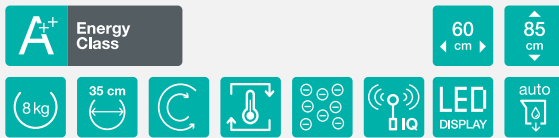

- Colour: Juicy Orange

Efficiency	<ul style="list-style-type: none"> - Single phase asynchronous motor - Dryer load: 1-8 kg - IonTech technology - TwinAir - Heat pump - Drum volume: 120 l - Drum illumination with LED light - Porthole diameter: 35 cm - Door opening angle: 180 ° - Reversible drum action - Direct discharge of condensate AutoDrain
Control	<ul style="list-style-type: none"> - Personal settings for all programmes - Type of display: LED - Presetting time delay of start
Programmes	<ul style="list-style-type: none"> - 15 programmes - Programmes: Bedding - programme for bedding and other large items, Wool, Shirts programme - lower temperature and slight remaining moisture to reduce wrinkles, Steam refresh, Mix dry, Mix iron dry - Drying time selection: Step setting
Functions	<ul style="list-style-type: none"> - Anticrease system - Refresh function
Features	<ul style="list-style-type: none"> - Audio signal SoftSound - FiltrationSupreme - Drying phase indicator - Signal for "full water container" - Remaining time on display - Vacuum feet
SensorIQ technology	<ul style="list-style-type: none"> - Humidity sensor - Service diagnostic indicator
Safety and durability	<ul style="list-style-type: none"> - Protective thermostat - Automatic switch off when door is open - Child protection (CDP) - Stainless steel inner/outer drum
Technical data	<ul style="list-style-type: none"> - Noise level: 65 dB(A)re 1 pW - Energy consumption kWh/year: 218 kWh - Product dimensions (HxWxD): 85 × 60 × 60 cm - EAN code: 3838942271885 - Product code: 454600



D 8565 NB

- Colour: Black
- EAN code: 3838942273414
- Product code: 454596



D 8565 NA

- Colour: Silver
- EAN code: 3838942272226
- Product code: 454599



D 8565 NR

- Colour: Fiery Red
- EAN code: 3838942272578
- Product code: 454597







FULLY QUALIFIED TO DO YOUR JOB

Smartflex dishwashers from Gorenje

The new SmartFlex dishwashers are inspired by modern lifestyle. Because our everyday life can be quite dynamic we created a generation of dishwasher that takes the load of your shoulders with the help of many advanced features.

The interior is designed in such a way that every dish and piece of cutlery has its place, no matter the shape or size. The baskets are equipped with highlighted movable elements and a customizable basket layout for easy loading, while the cutlery can be perfectly organized on a special tray where it can thoroughly dry out after washing. Furthermore, the SmartFlex dishwashers offer you a variety of helpful functions: a wide range of fast washing options that are among the best in the market and can take care of any load in no time, automatic opening of the door for releasing steam and letting the dishes dry out and the dissolving of bad odors through the natural process of ionization.



12 place settings

As flexible as your time will be

The SmartFlex dishwashers offer enough space for all your needs. Two baskets enable washing up to 12 place settings at a time. The fully flexible interior allows for different loading options, the use is simple and the washing effects are perfect.



Total AquaStop

Do not worry about water spillage

With the AquaStop safety feature, the dishwasher can be safely left to operate at night as well as in your absence. In case of a leakage or flooding, AquaStop automatically cuts off the water supply

while the pump siphons the residual water out of the dishwasher basin. AquaStop remains fully functional over the lifespan of the appliance.



GS 62010 SUK

Freestanding dishwasher

Essential Line



Energy Class



Washing Efficiency



Drying Efficiency



- Colour: Silver

GS 62010 WUK

Freestanding dishwasher

Essential Line



Energy Class



Washing Efficiency



Drying Efficiency



















- Colour: White

Efficiency	- Max. temperature of inflow water: 60 °C - Asynchronous single phase motor	- Max. temperature of inflow water: 60 °C - Asynchronous single phase motor
Control	- On/Off indicator - Control: Taste	- On/Off indicator - Control: Taste
Programmes	- Washing temperature(s): 60, 55, 45, 35 °C - 5 programmes: Quick programme; Intensive programme; Eco programme; Soaking; Daily wash - Reference programme: 3	- Washing temperature(s): 60, 55, 45, 35 °C - 5 programmes: Quick programme; Intensive programme; Eco programme; Soaking; Daily wash - Reference programme: 3
Features	- 12 place settings - Half load - Function 3 in 1 - Visual indicator for wash finish on control panel - Voice signal for the end of washing cycle	- 12 place settings - Half load - Function 3 in 1 - Visual indicator for wash finish on control panel - Voice signal for the end of washing cycle
Equipment	- Number of baskets: 2 - Upper basket system: Manual - Foldable bottom plate baskets - Number of water jet levels: 4 - Number of spray arms: 2 - Selfcleaning filter	- Number of baskets: 2 - Upper basket system: Manual - Foldable bottom plate baskets - Number of water jet levels: 4 - Number of spray arms: 2 - Selfcleaning filter
Safety	- Total AquaStop - Service diagnostics - Stainless steel tub	- Total AquaStop - Service diagnostics - Stainless steel tub
Consumption data (IEC standard EN 50242)	- Water consumption: 11 l - Energy consumption - normal program: 0,91 kWh - Estimated annual water consumption: 3080 l	- Water consumption: 11 l - Energy consumption - normal program: 0,91 kWh - Estimated annual water consumption: 3080 l
Technical data	- Height setting: 60 mm - Level of noise (max.): 49 dB(A)re 1 pW - Product dimensions (HxWxD): 85 × 60 × 58 cm - EAN code: 3838782019913 - Product code: 588564	- Height setting: 60 mm - Level of noise (max.): 49 dB(A)re 1 pW - Dimensions (HxWxD): 85 × 60 × 58 cm - EAN code: 3838782019807 - Code: 588562









Symbol description

COOKERS

	HomeMade oven
	GentleClose door hinge
	BigSpace, large oven capacity
	SuperSize baking area
	Triple glazed oven door with one heat deflector (CoolDoor)
	Double glazed oven door with one heat deflector (CompactDoor)
	Dynamic oven cooling - DC
	MultiAir technology
	MultiLevel baking
	OpenView
	XXL storage drawer
	MeatProbe
	SilverMatte (easy clean enamel surface)
	TouchFree Inox
	Induction hob
	BridgeZone
	PowerBoost, faster heating and cooking





	BoilControl prevents the food from boiling over
	ChefBurners
	Upper & lower heater
	Upper heater
	Lower heater
	Circular heater and fan
	Large infra grill
	Small grill
	Large infra grill and fan
	Lower heater and fan
	Lower heater with circular heater and fan
	Defrosting
	FastPreheat
	AquaClean
	WarmPlate, for professional service
	Gas thermostat
	Gas infrared burner

COOLING APPLIANCES

	NoFrost Plus
	NoFrost
	FrostLess - Less ice building in the freezer
	AdaptTech cooling - Memorizing intelligent system
	IonAir with the MultiFlow 360° function
	IonAir with DynamiiCooling
	Fan-assisted cooling in fridge
	ZeroZone drawer
	FreshActive drawer







	ConvertActive fridge freezer
	SuperCool function for rapid cooling of a major quantity of food
	CrispZone with HumidityControl - big vegetable drawer with humidity regulation
	FreshZone drawer
	FastFreeze - rapid food freezing
	CrispActive drawer
	PullOut shelves
	SimpleSlide shelves
	LED light







WASHING MACHINES

	Load 1-9 kg
	Load 1-8 kg
	Load 1-7 kg
	Load 1-6 kg
	SensorIQ system - advanced sensor technology
	Durable heater DuraHeat
	Total AquaStop, spill protection
	AquaStop, spill protection
	LED display
	LCD display
	FiberTech tub material
	CarboTech tub material

	SpaDrum, special drum construction
	StainExpert efficient stain removal
	TotalWeightControl
	Inverter PowerDrive efficient brushless motor
	Low temperature wash 20 °C
	SteriTub self-cleaning program
	StartDelay 24h in advance
	Spin speed 1600 rpm
	Spin speed 1400 rpm
	Spin speed 1200 rpm
	SuperSilent

TUMBLE DRYERS

	Load 1-9 kg
	Load 1-8 kg
	Load 1-7 kg
	SensorIQ system - advanced sensor technology
	Condenser dryer with a heat pump
	IonTech anti-bacterial treatment

	TwinAir - Special two-directional air blowing system
	SteamTech, steam drying technology
	AutoDrain - direct discharge of Condensate
	LED display
	LCD display
	Door opening 35 cm

DISHWASHERS

	Total AquaStop, total spill protection
	12 place settings
	Hot water connection



FREE 5- or 2- YEAR PARTS AND LABOUR GUARANTEE

Once you make your purchase you will need to register your appliance either online or over the phone, to register your Gorenje appliance online please visit our website www.gorenje.co.uk and go to “registration” OR to register over the phone please call **020 8247 3980**

Gorenje offer a free 5 or 2 year parts and labour guarantee. This guarantee shows our confidence in our technology and excellent product quality.



INVERTER POWERDRIVE MOTOR

Gorenje SensoCare washing machines are built to last. With the innovative inverter PowerDrive technology you will get an extra 10-year warranty on the motor.

AFTER SALES SUPPORT

Once you have bought a Gorenje appliance you can relax knowing that in unlikely event of a fault occurring, you can rely on us to look after your appliance. If you are experiencing problems and require customer support please contact our Service Hotline on:

0845 050 8555
(Republic of Ireland: 01 8835622)

Please have all your appliance details and date of purchase ready in order for your call to be dealt with efficiently.

Service Hotline opening times:

- Monday - Friday 8am - 6pm
- Saturday 9am - 4pm
- Sunday closed

gorenje

GORENJE UK Ltd
Tuition House
27-37 St George's Road
London
SW19 4EU
T 020 8247 39 80
F 020 8247 39 99
E info.uk@gorenje.com
www.gorenje.co.uk

www.parsital.com